

## PRODUCT FEATURES

- Ultrafast Recovery Time
- Low Recovery Loss
- Soft Reverse Recovery Characteristics
- Low Leakage Current
- Low Forward Voltage
- High Surge Current Capability

## APPLICATIONS

- Freewheeling, Snubber, Clamp
- Inversion Welder
- PFC
- Plating Power Supply
- Ultrasonic Cleaner and Welder
- Converter & Chopper
- UPS

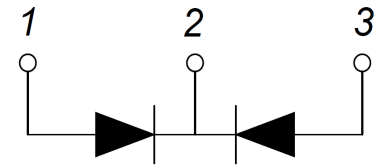
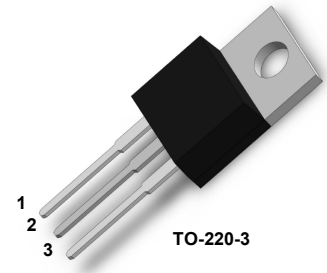

## DESCRIPTION

FRED from MacMic utilizes advanced processing techniques to achieve ultrafast recovery times and higher forward current. Its soft recovery characteristics and high reliability suit for wide industrial applications.

## ABSOLUTE MAXIMUM RATINGS

$T_C = 25^\circ\text{C}$  unless otherwise specified

Symbol	Parameter/Test Conditions		Values	Unit
$V_R$	Maximum D.C. Reverse Voltage		700	V
$V_{RRM}$	Maximum Repetitive Reverse Voltage			
$I_{F(AV)}$	Average Forward Current	$T_C = 110^\circ\text{C}$ , Per Diode	8	A
		$T_C = 110^\circ\text{C}$ , Per Package	16	
$I_{F(RMS)}$	RMS Forward Current	$T_C = 110^\circ\text{C}$ , Per Diode	11	
$I_{FSM}$	Non-Repetitive Surge Forward Current	$T_J = 45^\circ\text{C}$ , $t = 10\text{ms}$ , 50Hz, Sine	100	
$P_D$	Power Dissipation		50	W
$T_J$	Junction Temperature		-55 to +150	$^\circ\text{C}$
$T_{STG}$	Storage Temperature Range		-55 to +150	$^\circ\text{C}$
<b>Torque</b>	Module-to-Sink	Recommended (M3)	1.1	N•m
$R_{th(J-C)}$	Junction-to-Case Thermal Resistance Per Diode		2.5	$^\circ\text{C/W}$
<b>Weight</b>			2.5	g

## ELECTRICAL CHARACTERISTICS

$T_C = 25^\circ\text{C}$  unless otherwise specified

Symbol	Parameter/Test Conditions		Min.	Typ.	Max.	Unit
$I_{RM}$	Maximum Reverse Leakage Current	$V_R = 700\text{V}$			10	$\mu\text{A}$
		$V_R = 700\text{V}$ , $T_J = 125^\circ\text{C}$			10	mA
$V_F$	Forward Voltage	$I_F = 8\text{A}$		1.3	1.6	V
		$I_F = 8\text{A}$ , $T_J = 125^\circ\text{C}$		1.15		
$t_{rr}$	Reverse Recovery Time ( $I_F = 1\text{A}$ , $diF/dt = -200\text{A}/\mu\text{s}$ , $V_R = 30\text{V}$ )			19		ns
$t_{rr}$	Reverse Recovery Time			130		ns
$I_{RRM}$	Maximum Reverse Recovery Current			3		A
$t_{rr}$	Reverse Recovery Time			200		ns
$I_{RRM}$	Maximum Reverse Recovery Current			5.5		A
<b>S</b>				4.5		

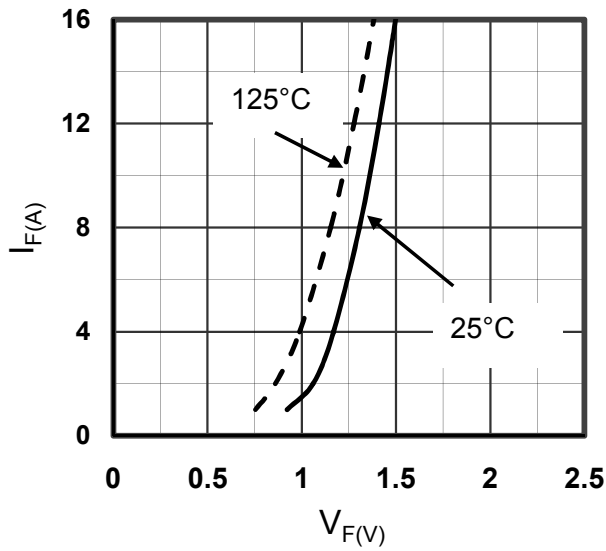

Figure1. Forward Voltage Drop vs Forward Current

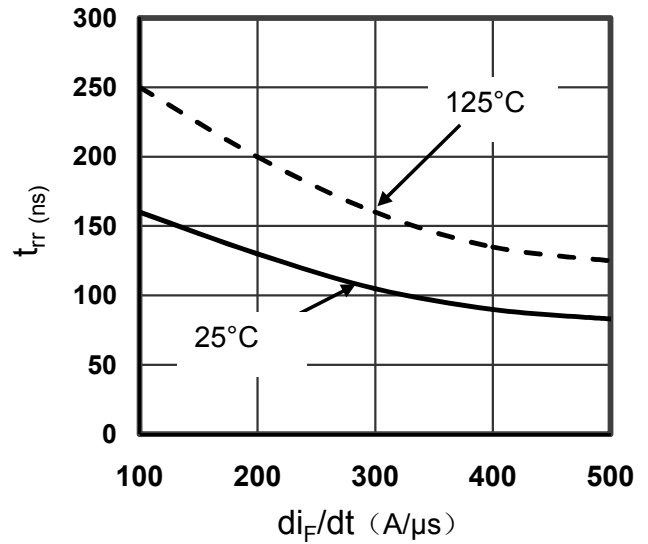

Figure2. Reverse Recovery Time vs diF/dt

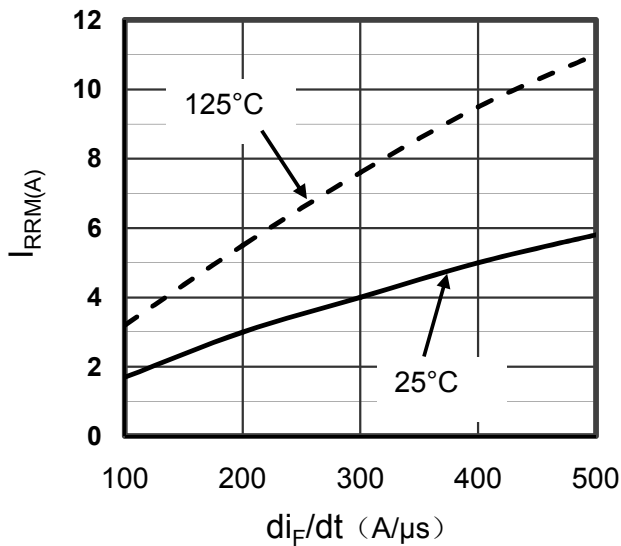

Figure3. Reverse Recovery Current vs diF/dt

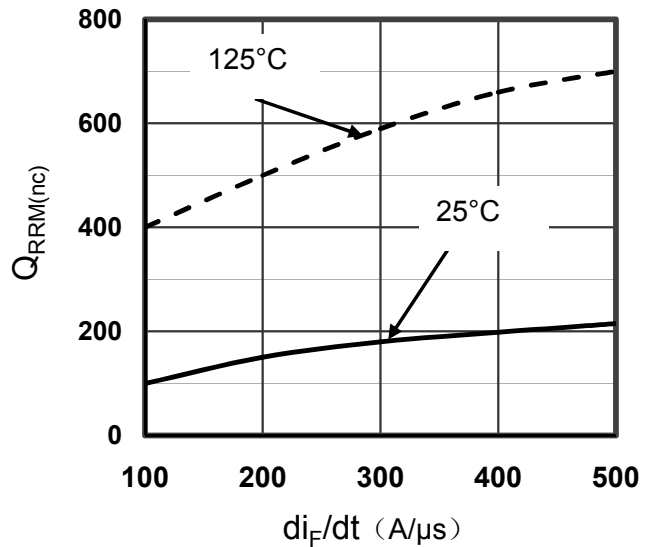

Figure4. Reverse Recovery Charge vs diF/dt

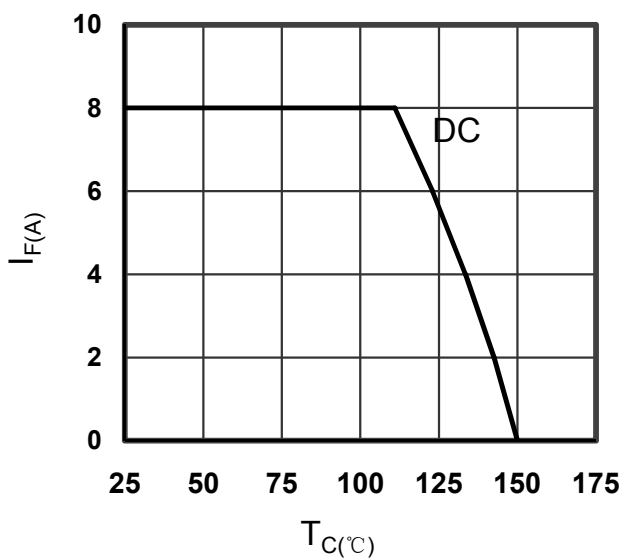

Figure5. Forward current vs. Case temperature

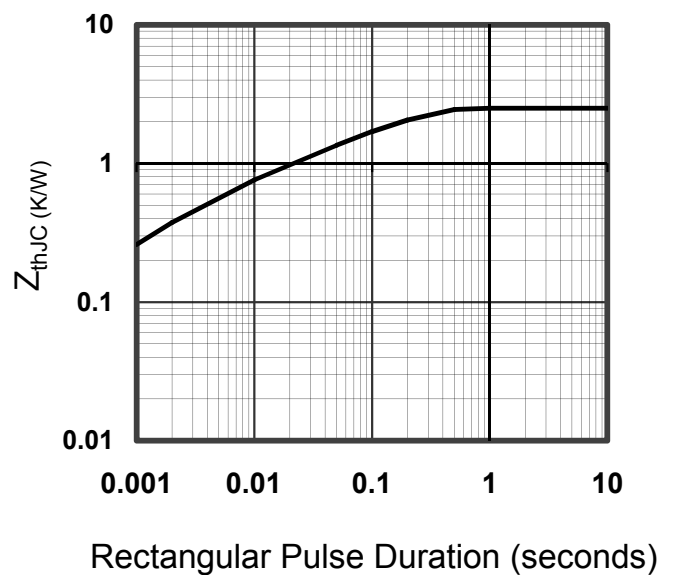

Figure6. Transient Thermal Impedance<sub>2</sub>

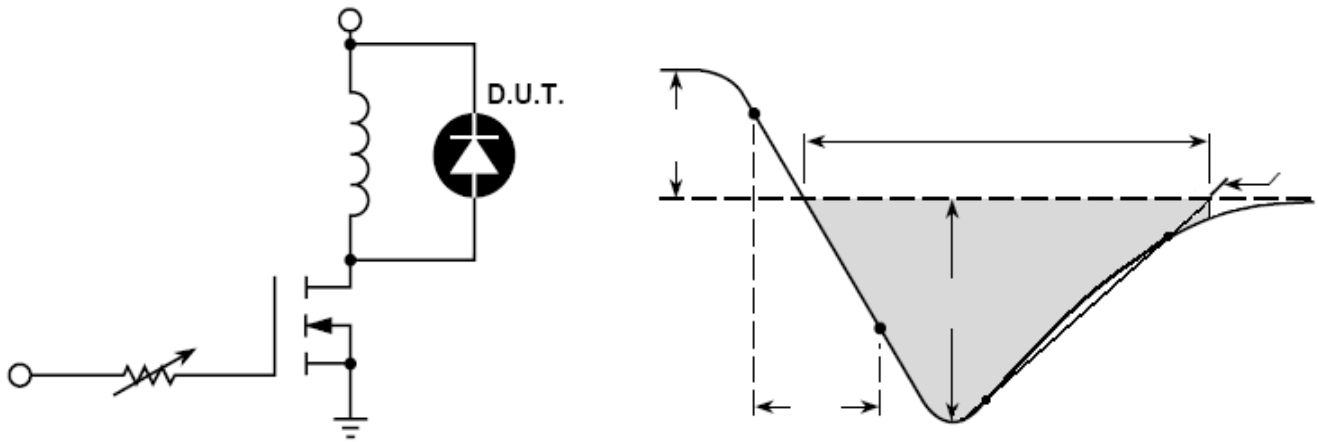
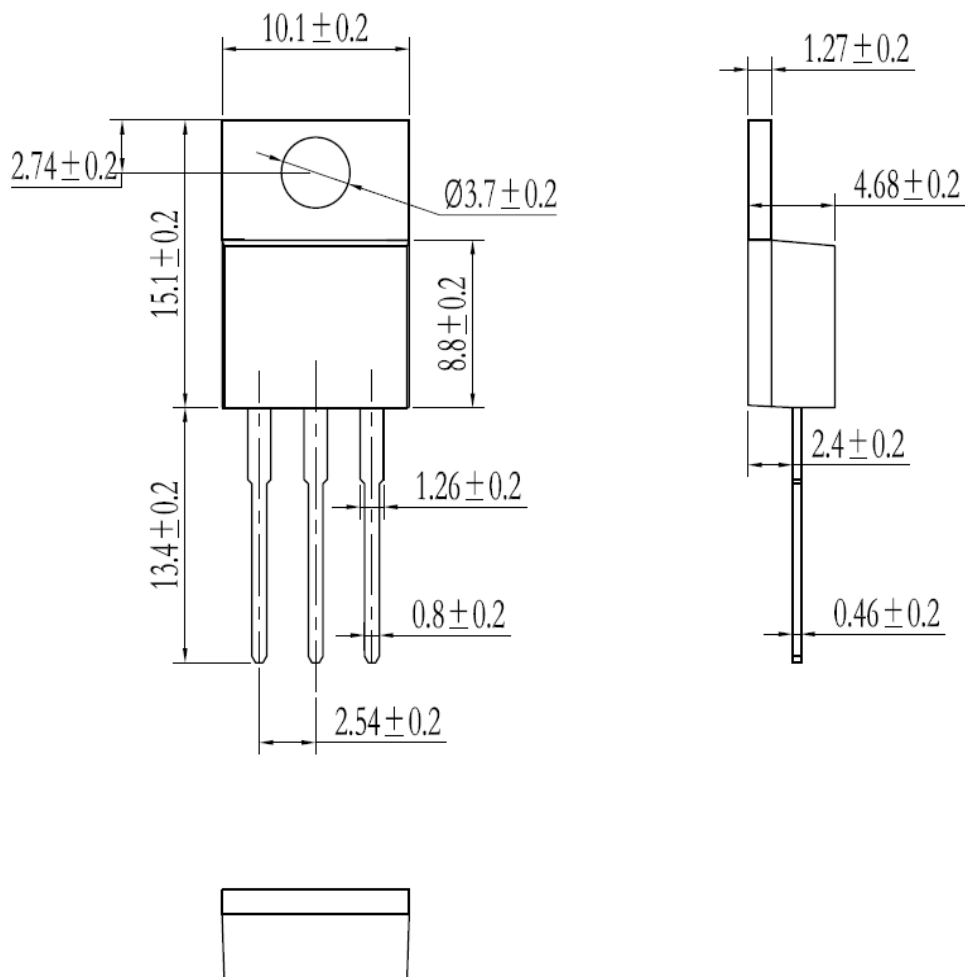

Figure7. Diode Reverse Recovery Test Circuit and Waveform



Dimensions in Millimeters  
Figure8. Package Outline