

PRODUCT FEATURES

- Low Forward Voltage
- High Surge Current Capability
- Low Leakage Current
- Low Inductance Package

APPLICATIONS

- Field Supply For DC Motors
- Line Rectifiers For Transistorized AC Motor Controllers
- Non-controllable Rectifiers For AC/DC Converter

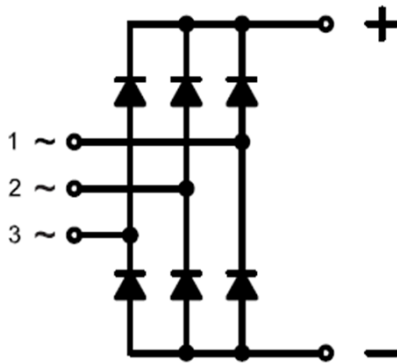

Module Type

Module Type	V_{RRM} (Repetitive Peak Reverse Voltage)	V_{RSM} (Non-Repetitive Peak Reverse Voltage)	Unit
MMD100F200X	2000	2100	V

ABSOLUTE MAXIMUM RATINGS

$T_C = 25^\circ\text{C}$ unless otherwise specified

Symbol	Parameter/Test Conditions		Values	Unit	
I_D	Output Current(D.C.)	Three phase, half wave, $T_C = 95^\circ\text{C}$	100	A	
I_{FSM}	Non Repetitive Surge Forward Current	1/2 cycle, 50Hz, peak value, $T_C = 45^\circ\text{C}$	1000		
		1/2 cycle, 60Hz, peak value, $T_C = 45^\circ\text{C}$	1100		
I^2t	For Fusing	1/2 cycle, 50Hz, peak value, $T_C = 45^\circ\text{C}$	5.0	KA ² S	
		1/2 cycle, 60Hz peak value, $T_C = 45^\circ\text{C}$	5.1		
P_D	Power Dissipation		830	W	
T_J	Junction Temperature		-40 to +150	$^\circ\text{C}$	
T_{STG}	Storage Temperature Range		-40 to +125	$^\circ\text{C}$	
V_{ISO}	Isolation Breakdown Voltage	AC, 50Hz(R.M.S), t=1minute	3000	V	
Torque	Module to Sink	Recommended (M6)	3~5	Nm	
Torque	Module Electrodes	Recommended (M6)	3~5	Nm	
R_{thJC}	Junction to Case Thermal Resistance		per diode	0.9	K /W
			per module	0.15	
Weight			250	g	

ELECTRICAL CHARACTERISTICS

$T_C = 25^\circ\text{C}$ unless otherwise specified

Symbol	Parameter/Test Conditions	Min.	Typ.	Max.	Unit
I_{RM}	Maximum Reverse Leakage Current	$V_R = V_{RRM}$		1	mA
		$V_R = V_{RRM}, T_J = 125^\circ\text{C}$		10	
V_F	Forward Voltage Drop			1.35	V
V_{TO}	For power loss calculations only, $T_J = 125^\circ\text{C}$			0.86	V
r_T				4.9	m Ω

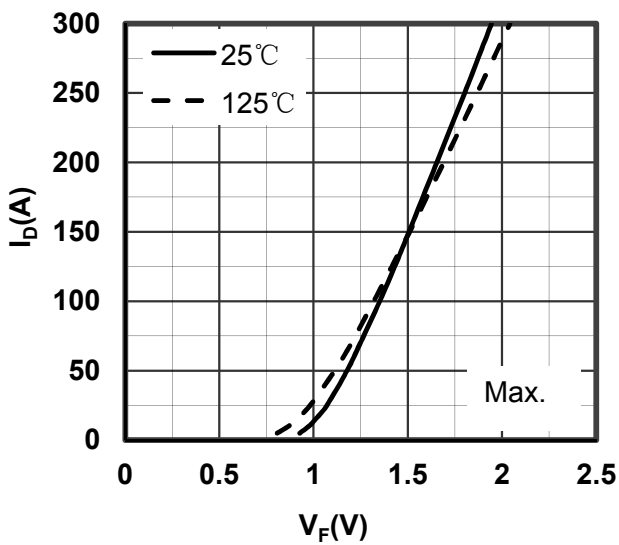

Figure 1. Forward Voltage Drop vs Output Current

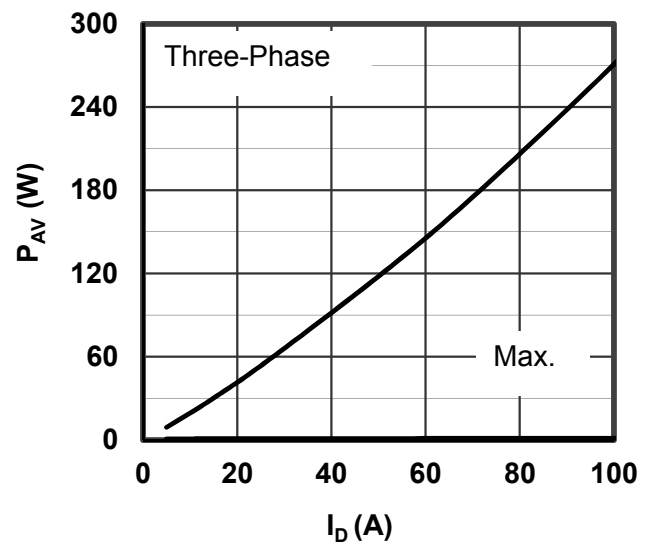

Figure 2. Power dissipation vs Output Current

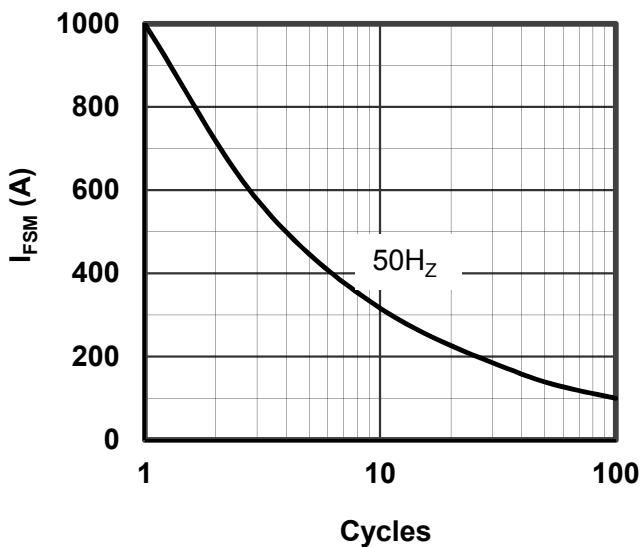

Figure 3. Max Non Repetitive Forward Surge Current

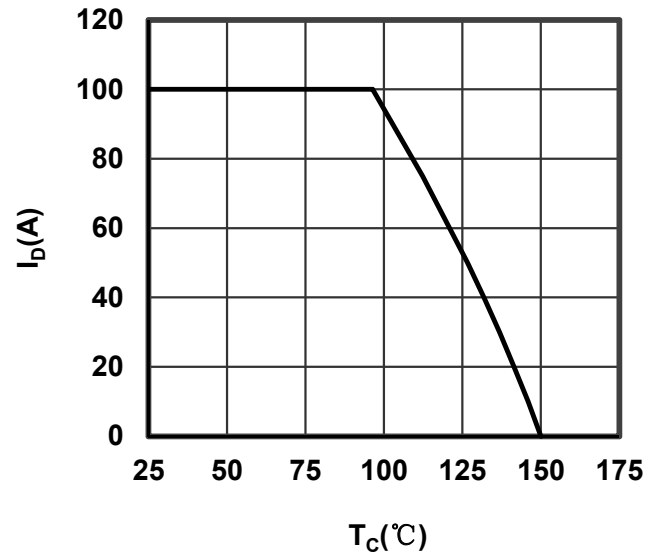

Figure 4. Output current vs Case temperature

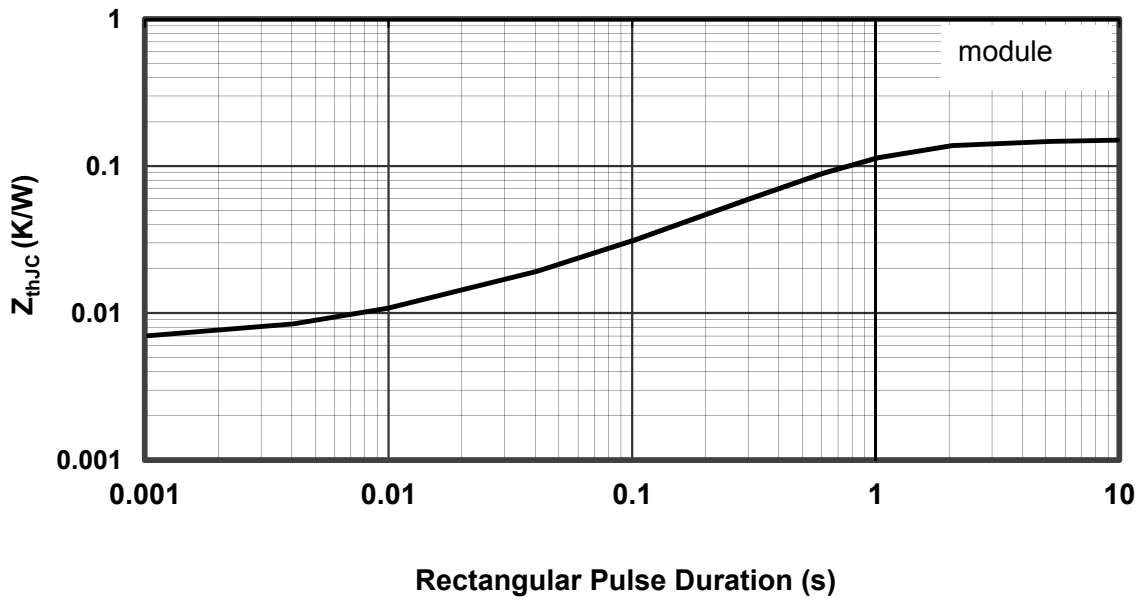
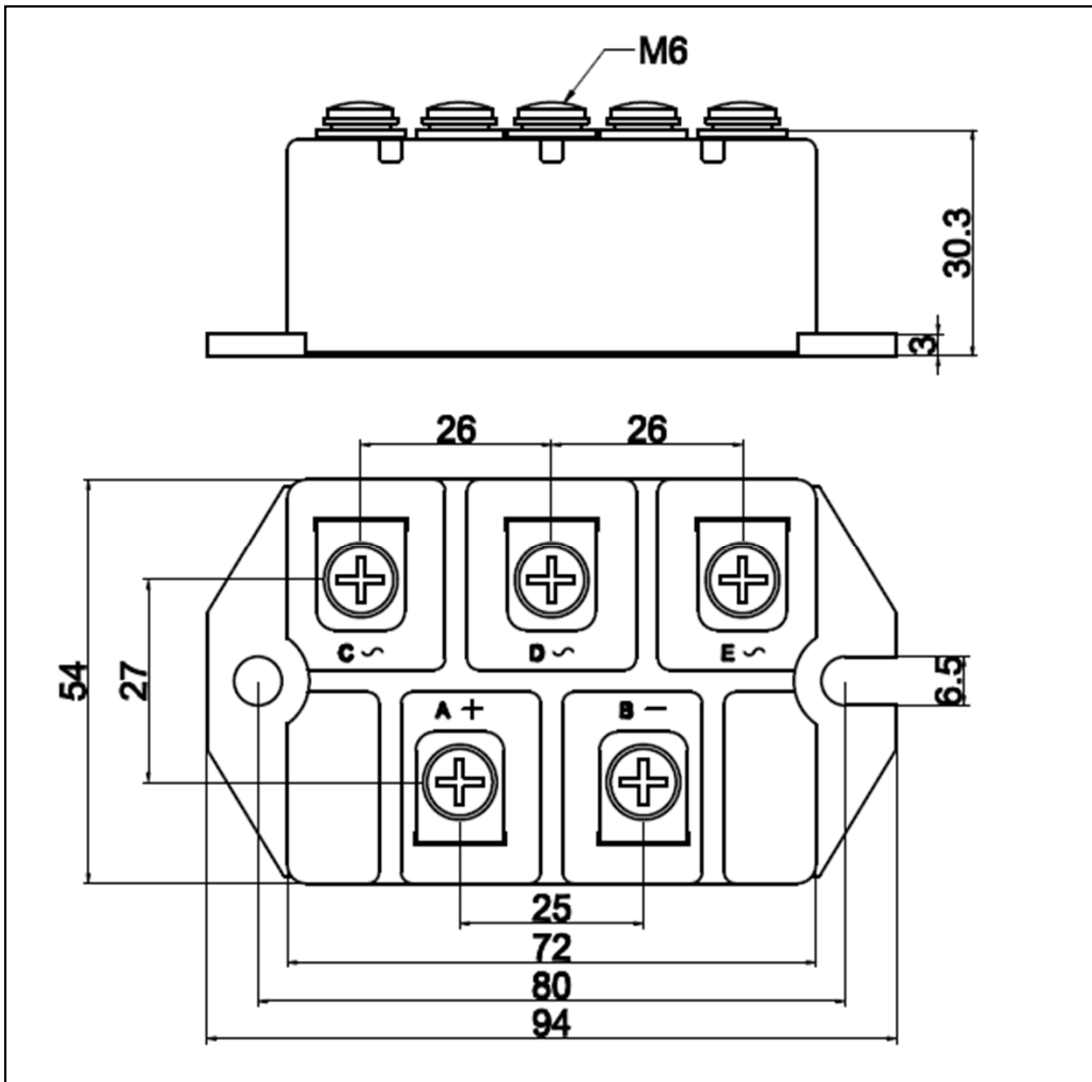

Figure 5. Transient Thermal Impedance



Dimensions in (mm)
Figure 6. Package Outline