

PRODUCT FEATURES

- Low Forward Voltage
- High Surge Current Capability
- Low Leakage Current
- Low Inductance Package

APPLICATIONS

- Field Supply For DC Motors
- Line Rectifiers For Transistorized AC Motor Controllers
- Non-controllable Rectifiers For AC/DC Converter

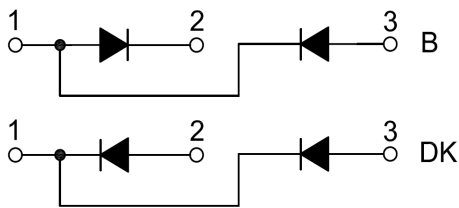

Module Type

Module Type	Circuit Diagram		V_{RRM} (Repetitive Peak Reverse Voltage)	V_{RSM} (Non-Repetitive Peak Reverse Voltage)	Unit
	B	DK			
MMD60A120B	MMD60A120DK	1200	1300	V	
MMD60A140B	MMD60A140DK	1400	1500		
MMD60A160B	MMD60A160DK	1600	1700		
MMD60A180B	MMD60A180DK	1800	1900		

ABSOLUTE MAXIMUM RATINGS

$T_C=25^\circ\text{C}$ unless otherwise specified

Symbol	Parameter/Test Conditions		Values	Unit
$I_{F(AV)}$	Average Forward Current	Single phase, half wave, 180° conduction, $T_c=90^\circ\text{C}$	60	A
$I_{F(RMS)}$	R.M.S. Forward Current	Single phase, half wave, 180° conduction, $T_c=90^\circ\text{C}$	94	
I_{FSM}	Non-Repetitive Surge Forward Current	1/2 cycle, 50HZ, peak value $T_c=45^\circ\text{C}$	1350	
		1/2 cycle, 60HZ, peak value, $T_c=45^\circ\text{C}$	1450	
I^2t	For Fusing	1/2 cycle, 50HZ, peak value $T_c=45^\circ\text{C}$	9.1	KA ² S
		1/2 cycle, 60HZ, peak value, $T_c=45^\circ\text{C}$	8.7	
P_D	Power Dissipation		195	W
T_J	Junction Temperature		-40 to +150	°C
T_{STG}	Storage Temperature Range		-40 to +125	°C
V_{ISO}	Isolation Breakdown Voltage	AC, 50Hz(R.M.S), t=1minute	3000	V
Torque	Module to Sink	Recommended (M6)	3~5	Nm
Torque	Module Electrodes	Recommended (M5)	2.5~5	Nm
R_{thJC}	Junction to Case Thermal Resistance		0.63	K/W
Weight			110	g

ELECTRICAL CHARACTERISTICS

$T_C = 25^\circ\text{C}$ unless otherwise specified

Symbol	Parameter/Test Conditions	Min.	Typ.	Max.	Unit
I_{RM}	Maximum Reverse Leakage Current			0.5	mA
				$V_R = V_{RRM}, T_J = 125^\circ\text{C}$	
V_F	Forward Voltage Drop			1.5	V
V_{TO}	For power-loss calculations only, $T_J = 125^\circ\text{C}$			0.85	V
r_T				3.6	m Ω

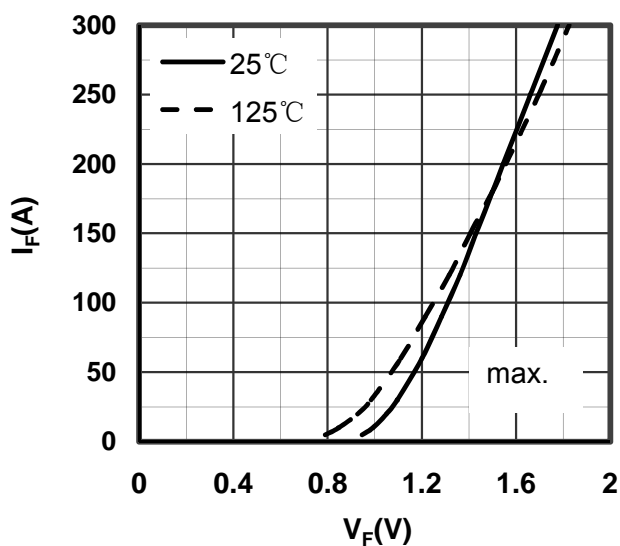

Figure 1. Forward Voltage Drop vs Forward Current

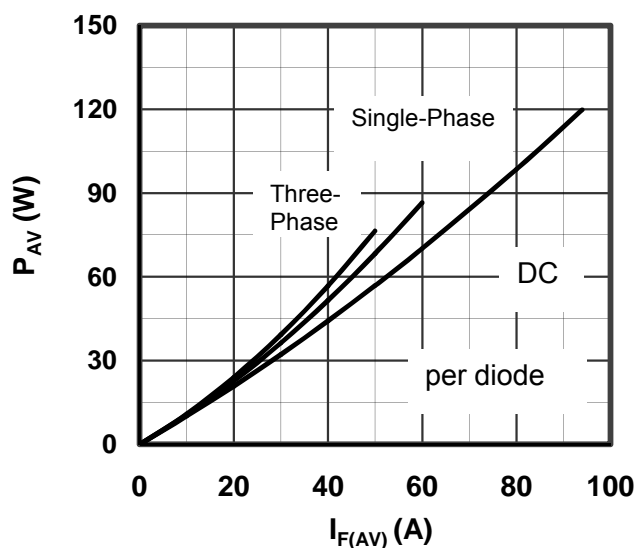

Figure 2. Power dissipation vs $I_{F(AV)}$

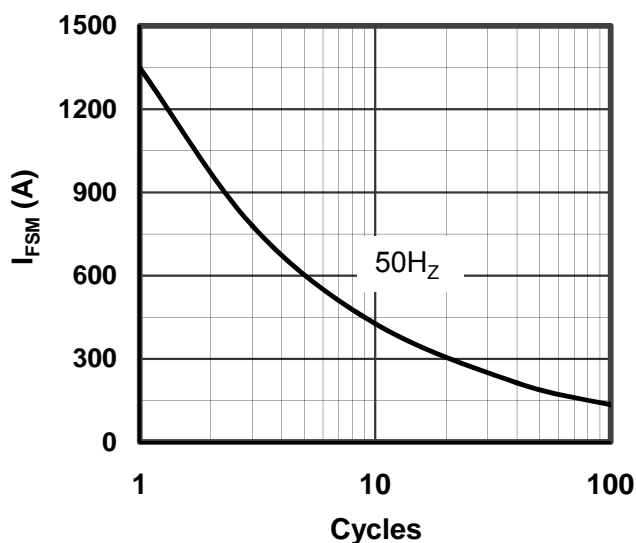

Figure 3. Max Non-Repetitive Forward Surge Current

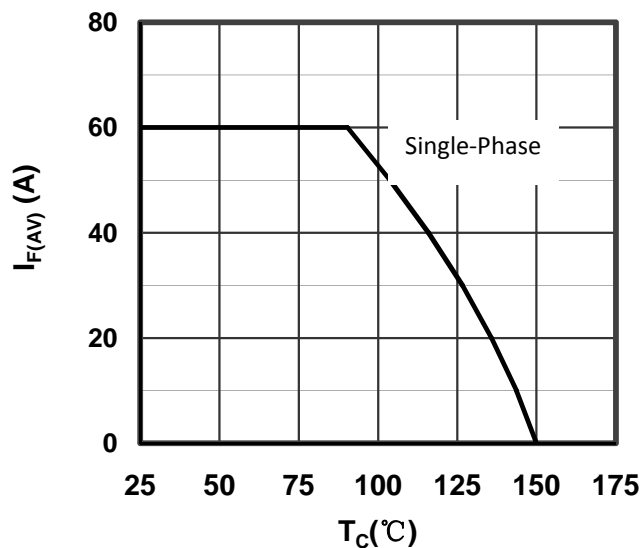

Figure 4. Forward current vs Case temperature

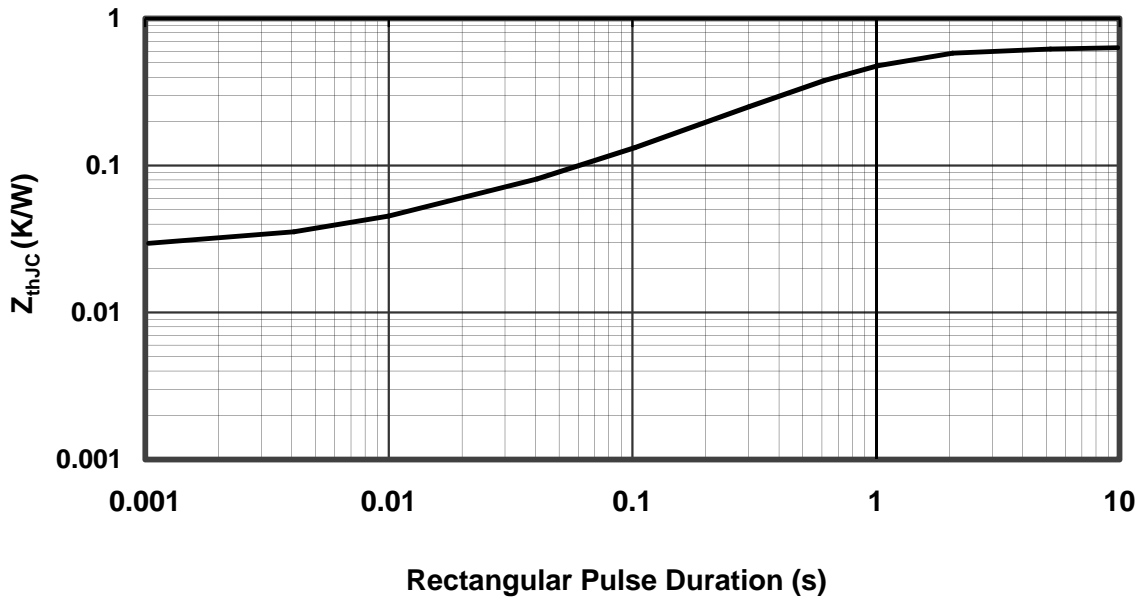
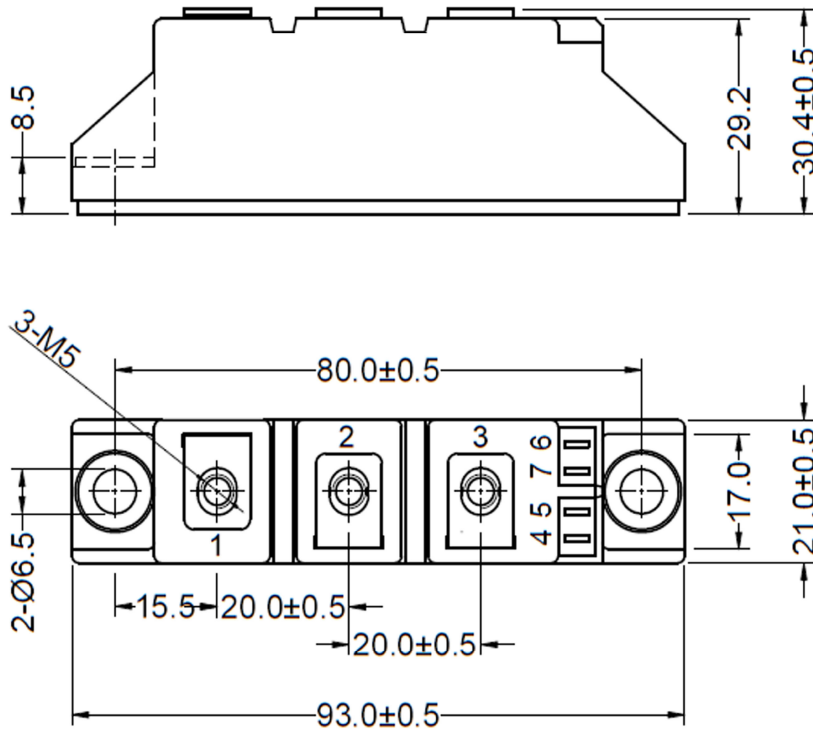

Figure 5. Transient Thermal Impedance



Dimensions in (mm)
Figure 6. Package Outline