

PRODUCT FEATURES

- Ultrafast Reverse Recovery Time
- Soft Reverse Recovery Characteristics
- Low Reverse Recovery Loss
- Low Forward Voltage
- High Surge Current Capability
- Low Leakage Current



APPLICATIONS

- Inversion Welder
- Uninterruptible Power Supply
- Plating Power Supply
- Ultrasonic Cleaner and Welder
- Converter & Chopper
- PFC

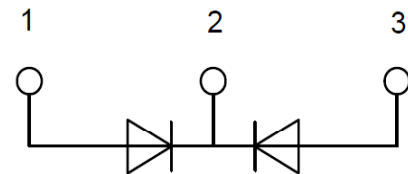

ABSOLUTE MAXIMUM RATINGS ($T_C = -25^\circ\text{C}$ unless otherwise specified)

| Symbol | Parameter/Test Conditions | | Values | Unit |
|--------------|--|--|-------------|---------------------------|
| V_R | Maximum D.C. Reverse Voltage | | 200 | V |
| V_{RRM} | Maximum Repetitive Reverse Voltage | | | |
| $I_{F(AV)}$ | Average Forward Current | $T_C = 80^\circ\text{C}$, Per Diode | 200 | A |
| | | $T_C = 80^\circ\text{C}$, Per Module | 400 | |
| $I_{F(RMS)}$ | RMS Forward Current | $T_C = 80^\circ\text{C}$, Per Diode | 282 | |
| I_{FSM} | Non Repetitive Surge Forward Current | $T_J = 45^\circ\text{C}$, $t = 10\text{ms}$, Sine, peak value | 2000 | |
| | | $T_J = 45^\circ\text{C}$, $t = 8.3\text{ms}$, Sine, peak value | 2200 | |
| I^2t | For Fusing | $T_J = 45^\circ\text{C}$, $t = 10\text{ms}$, Sine, peak value | 20000 | A^2S |
| | | $T_J = 45^\circ\text{C}$, $t = 8.3\text{ms}$, Sine, peak value | 20086 | |
| P_D | Power Dissipation | | 370 | W |
| T_J | Junction Temperature | | -40 to +150 | $^\circ\text{C}$ |
| T_{STG} | Storage Temperature Range | | -40 to +125 | $^\circ\text{C}$ |
| V_{isol} | Isolation Breakdown Voltage | AC, 50Hz(R.M.S), $t = 1\text{minute}$ | 3000 | V |
| Torque | Module to Sink | Recommended (M5) | 2.5~4 | Nm |
| Torque | Module Electrodes | Recommended (M5) | 2.5~4 | Nm |
| R_{thJC} | Junction to Case Thermal Resistance(Per Diode) | | 0.34 | $^\circ\text{C}/\text{W}$ |
| Weight | | | 100 | g |

MacMic Science & Technology Co., Ltd.

Add: #18, Hua Shan Zhong Lu, New District, Changzhou City, Jiangsu Province, P. R. of China

MMF400N020DK2B

ELECTRICAL CHARACTERISTICS ($T_C=25^\circ\text{C}$ unless otherwise specified)

| Symbol | Parameter/Test Conditions | Min. | Typ. | Max. | Unit |
|-----------|---|--|------|------|------|
| I_{RM} | Maximum Reverse Leakage Current | $V_R = 200\text{V}$ | | 1 | mA |
| | | $V_R = 200\text{V}, T_J = 125^\circ\text{C}$ | | 10 | |
| V_F | Forward Voltage | $I_F=200\text{A}$ | 0.9 | 1.15 | V |
| | | $I_F=200\text{A}, T_J=125^\circ\text{C}$ | | 0.8 | |
| t_{rr} | Reverse Recovery Time ($I_F = 1\text{A}, di_F/dt = -200\text{A}/\mu\text{s}, V_R = 30\text{V}$) | | 42 | | ns |
| t_{rr} | Reverse Recovery Time | | 135 | | ns |
| I_{RRM} | Maximum Reverse Recovery Current | | 15.5 | | A |
| t_{rr} | Reverse Recovery Time | | 195 | | ns |
| I_{RRM} | Maximum Reverse Recovery Current | | 23 | | A |

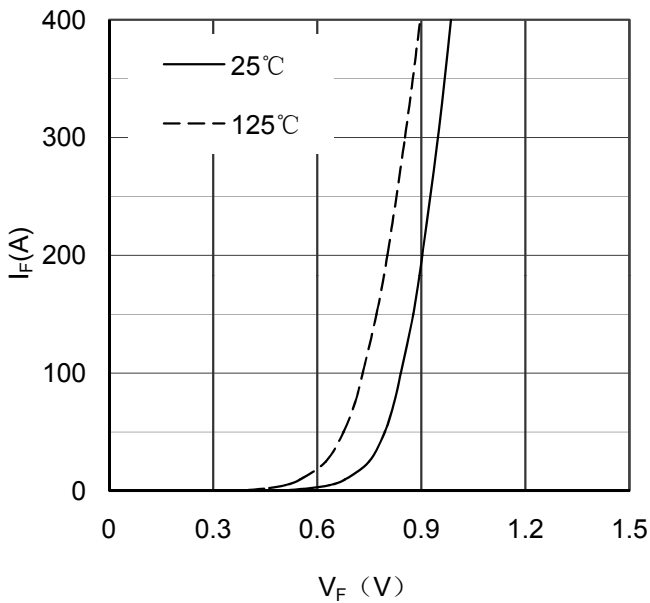

Figure 1. Forward Voltage Drop vs Forward Current

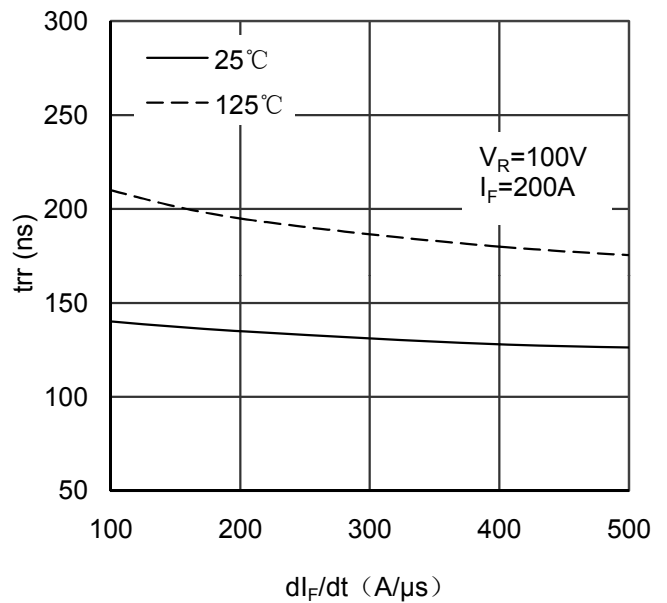

Figure 2. Reverse Recovery Time vs di_F/dt

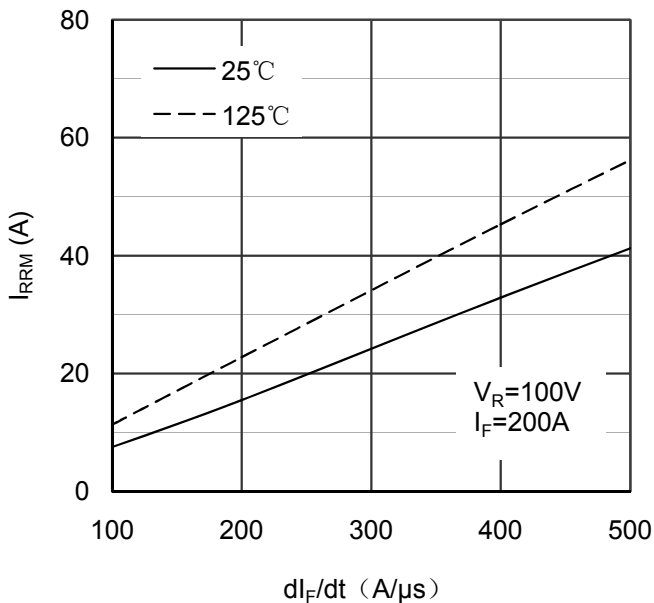

Figure 3. Reverse Recovery Current vs di_F/dt

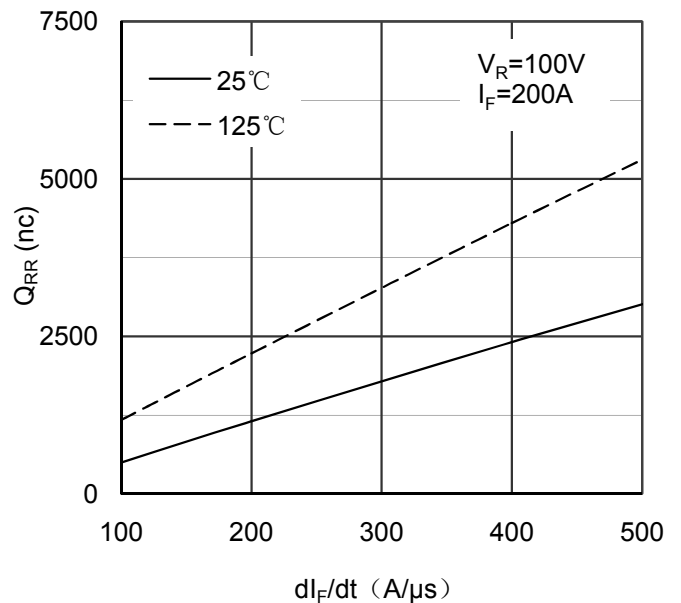

Figure 4. Reverse Recovery Charge vs di_F/dt

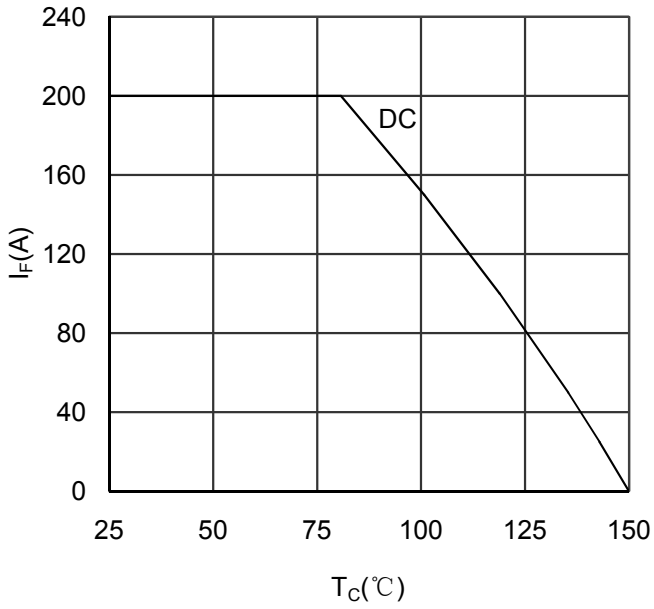

Figure 5. Forward current vs Case temperature

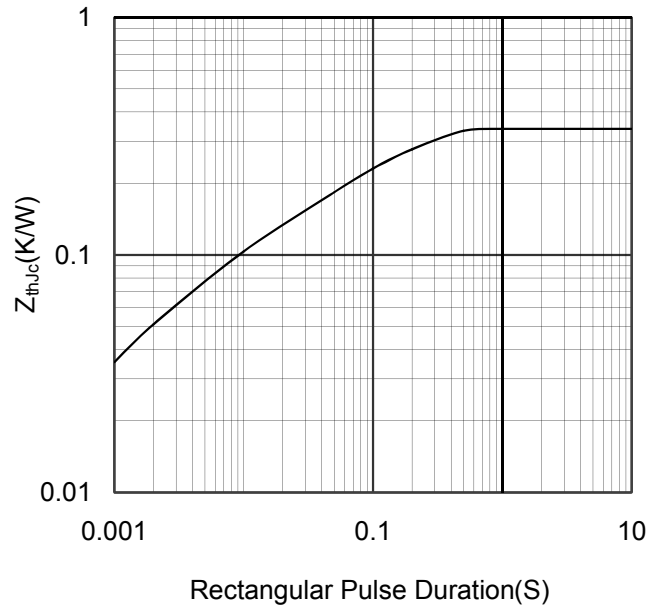
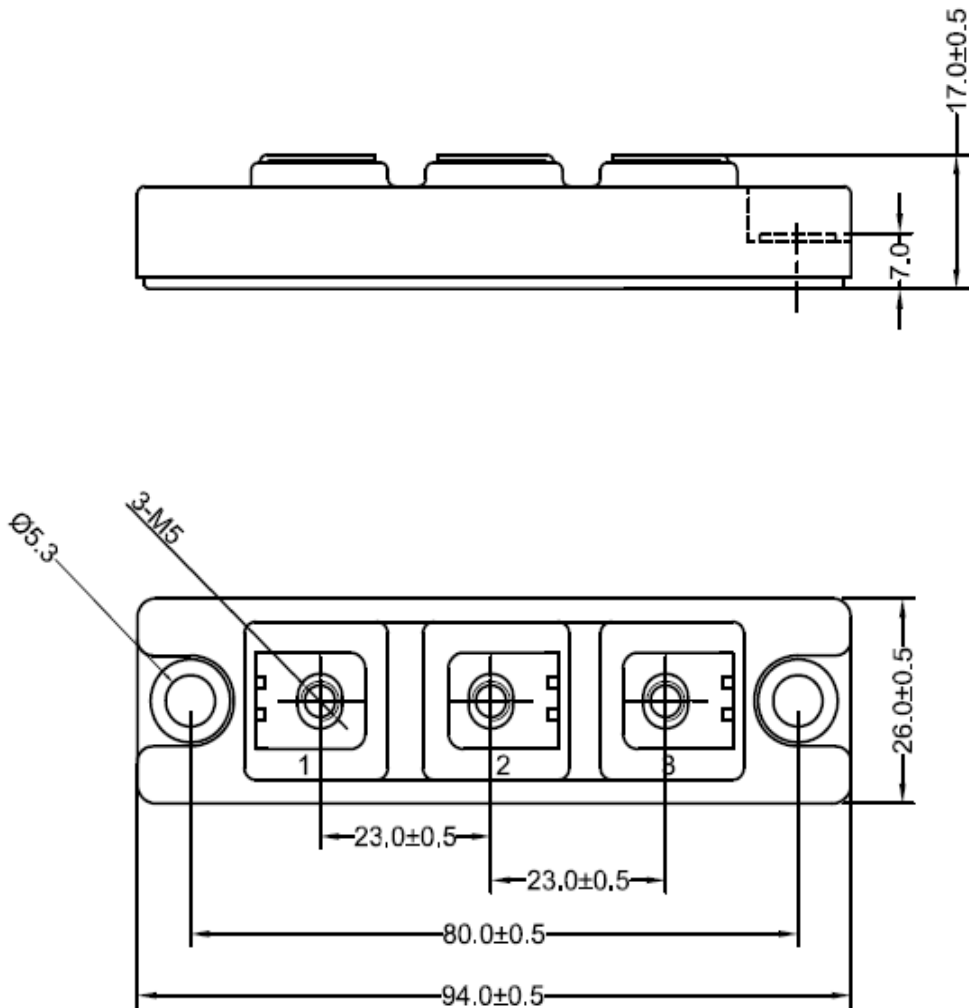

Figure 6. Transient Thermal Impedance



Dimensions in (mm)

Figure 7. Package Outline