

## PRODUCT FEATURES

- IGBT CHIP(Trench+Field Stop technology)
- Substrate for Low Thermal Resistance
- Low saturation voltage and positive temperature coefficient
- Fast switching and short tail current
- Free wheeling diodes with fast and soft reverse recovery
- Solder Contact Technology, Rugged mounting due to integrated Mounting clamps
- Temperature sense included

## APPLICATIONS

- AC motor control
- Motion/servo control
- Inverter and power supplies

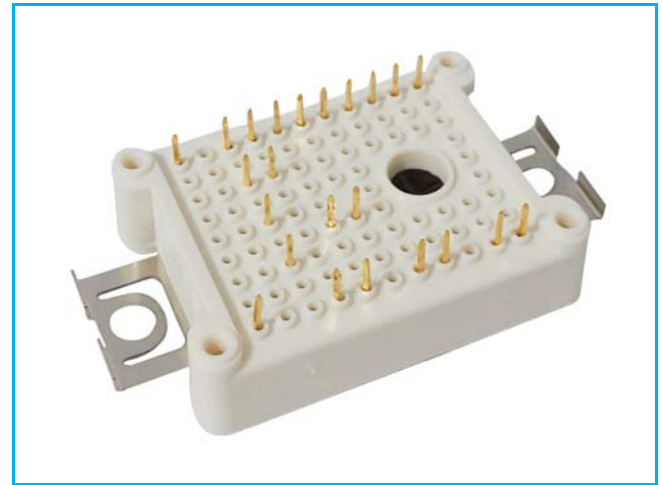

### IGBT-inverter

ABSOLUTE MAXIMUM RATINGS( $T_C=25^{\circ}\text{C}$  unless otherwise specified)

Symbol	Parameter/Test Conditions		Values	Unit
$V_{CES}$	Collector Emitter Voltage	$T_J=25^{\circ}\text{C}$	1200	V
$V_{GES}$	Gate Emitter Voltage		$\pm 20$	
$I_C$	DC Collector Current	$T_C=25^{\circ}\text{C}, T_{Jmax}=175^{\circ}\text{C}$	19	A
		$T_C=105^{\circ}\text{C}, T_{Jmax}=175^{\circ}\text{C}$	10	
$I_{CM}$	Repetitive Peak Collector Current	$t_p=1\text{ms}$	20	
$P_{tot}$	Power Dissipation Per IGBT	$T_C=25^{\circ}\text{C}, T_{Jmax}=175^{\circ}\text{C}$	107	W

### Diode-inverter

ABSOLUTE MAXIMUM RATINGS ( $T_C=25^{\circ}\text{C}$  unless otherwise specified)

Symbol	Parameter/Test Conditions		Values	Unit
$V_{RRM}$	Repetitive Reverse Voltage	$T_J=25^{\circ}\text{C}$	1200	V
$I_{F(AV)}$	Average Forward Current		10	A
$I_{FRM}$	Repetitive Peak Forward Current	$t_p=1\text{ms}$	20	
$I^2t$		$T_J=125^{\circ}\text{C}, t=10\text{ms}, V_R=0\text{V}$	18	$\text{A}^2\text{S}$

MacMic Science & Technology Co., Ltd.

Add: #18, Hua Shan Zhong Lu, New District, Changzhou City, Jiangsu Province, P. R. of China

Tel.: +86-519-85163708 Fax: +86-519-85162291 Post Code: 213022 Website: www.macmicst.com

# MMG10CB120X6TC

## IGBT-inverter

### ELECTRICAL CHARACTERISTICS ( $T_C=25^\circ\text{C}$ unless otherwise specified)

Symbol	Parameter/Test Conditions		Min.	Typ.	Max.	Unit	
$V_{GE(th)}$	Gate Emitter Threshold Voltage	$V_{CE}=V_{GE}, I_C=0.25\text{mA}$	5.0	5.8	6.5	V	
$V_{CE(sat)}$	Collector Emitter Saturation Voltage	$I_C=10\text{A}, V_{GE}=15\text{V}, T_J=25^\circ\text{C}$		1.85	2.25		
		$I_C=10\text{A}, V_{GE}=15\text{V}, T_J=125^\circ\text{C}$		2.15			
		$I_C=10\text{A}, V_{GE}=15\text{V}, T_J=150^\circ\text{C}$		2.25			
$I_{CES}$	Collector Leakage Current	$V_{CE}=1200\text{V}, V_{GE}=0\text{V}, T_J=25^\circ\text{C}$			100	$\mu\text{A}$	
		$V_{CE}=1200\text{V}, V_{GE}=0\text{V}, T_J=150^\circ\text{C}$			10	$\text{mA}$	
$I_{GES}$	Gate Leakage Current	$V_{CE}=0\text{V}, V_{GE}=\pm 20\text{V}, T_J=25^\circ\text{C}$	-400		400	$\text{nA}$	
$R_{gint}$	Integrated Gate Resistor			0		$\Omega$	
$Q_g$	Gate Charge	$V_{CE}=600\text{V}, I_C=10\text{A}, V_{GE}=15\text{V}$		0.08		$\mu\text{C}$	
$C_{ies}$	Input Capacitance	$V_{CE}=25\text{V}, V_{GE}=0\text{V}, f=1\text{MHz}$		0.8		$\text{nF}$	
$C_{res}$	Reverse Transfer Capacitance				35		$\text{pF}$
$t_{d(on)}$	Turn on Delay Time	$V_{CC}=600\text{V}, I_C=10\text{A}$ $R_G=50\Omega,$ $V_{GE}=\pm 15\text{V},$ Inductive Load	$T_J=25^\circ\text{C}$		20	$\text{ns}$	
			$T_J=125^\circ\text{C}$		25	$\text{ns}$	
			$T_J=150^\circ\text{C}$		25	$\text{ns}$	
$t_r$	Rise Time		$T_J=25^\circ\text{C}$		22	$\text{ns}$	
			$T_J=125^\circ\text{C}$		24	$\text{ns}$	
			$T_J=150^\circ\text{C}$		24	$\text{ns}$	
$t_{d(off)}$	Turn off Delay Time	$T_J=25^\circ\text{C}$		150	$\text{ns}$		
		$T_J=125^\circ\text{C}$		180	$\text{ns}$		
		$T_J=150^\circ\text{C}$		210	$\text{ns}$		
$t_f$	Fall Time	$T_J=25^\circ\text{C}$		180	$\text{ns}$		
		$T_J=125^\circ\text{C}$		215	$\text{ns}$		
		$T_J=150^\circ\text{C}$		225	$\text{ns}$		
$E_{on}$	Turn on Energy	$V_{CC}=600\text{V}, I_C=10\text{A}$ $R_G=50\Omega,$ $V_{GE}=\pm 15\text{V},$ Inductive Load	$T_J=125^\circ\text{C}$		1.15	$\text{mJ}$	
			$T_J=150^\circ\text{C}$		1.25	$\text{mJ}$	
$E_{off}$	Turn off Energy		$T_J=125^\circ\text{C}$		0.69	$\text{mJ}$	
			$T_J=150^\circ\text{C}$		0.72	$\text{mJ}$	
$I_{SC}$	Short Circuit Current		$t_{psc} \leq 10\mu\text{s}, V_{GE}=15\text{V}$ $T_J=150^\circ\text{C}, V_{CC}=800\text{V}$		40		A
$R_{thJC}$	Junction to Case Thermal Resistance ( Per IGBT )			1.25	1.4	$\text{K/W}$	

## Diode-inverter

### ELECTRICAL CHARACTERISTICS ( $T_C=25^\circ\text{C}$ unless otherwise specified)

Symbol	Parameter/Test Conditions		Min.	Typ.	Max.	Unit
$V_F$	Forward Voltage	$I_F=10\text{A}, V_{GE}=0\text{V}, T_J=25^\circ\text{C}$		1.95	2.45	V
		$I_F=10\text{A}, V_{GE}=0\text{V}, T_J=125^\circ\text{C}$		1.55		
		$I_F=10\text{A}, V_{GE}=0\text{V}, T_J=150^\circ\text{C}$		1.5		
$t_{rr}$	Reverse Recovery Time	$I_F=10\text{A}, V_R=600\text{V}$ $di_F/dt=-500\text{A}/\mu\text{s}$ $T_J=150^\circ\text{C}$		161		$\text{ns}$
$I_{RRM}$	Max. Reverse Recovery Current			15		A
$Q_{RR}$	Reverse Recovery Charge			1.6		$\mu\text{C}$
$E_{rec}$	Reverse Recovery Energy			0.57		$\text{mJ}$
$R_{thJCD}$	Junction to Case Thermal Resistance ( Per Diode )			1.75	1.9	$\text{K/W}$

# MMG10CB120X6TC

## NTC CHARACTERISTICS ( $T_C=25^\circ\text{C}$ unless otherwise specified)

Symbol	Parameter/Test Conditions	Min.	Typ.	Max.	Unit
$R_{25}$	Resistance $T_C = 25^\circ\text{C}$		5		$\text{K}\Omega$
$B_{25/50}$	$R_2 = R_{25} \exp [B_{25/50}(1/T_2 - 1/(298.15 \text{ K}))]$		3375		K

## MODULE CHARACTERISTICS ( $T_C=25^\circ\text{C}$ unless otherwise specified)

Symbol	Parameter/Test Conditions	Values	Unit
$T_{Jmax}$	Max. Junction Temperature	175	°C
$T_{Jop}$	Operating Temperature	-40~150	
$T_{stg}$	Storage Temperature	-40~125	
$V_{isol}$	Isolation Breakdown Voltage AC, 50Hz(R.M.S), t=1minute	3000	V
CTI	Comparative Tracking Index	>200	
F	Mounting Force Per Clamp	20~50	N
Weight		25	g

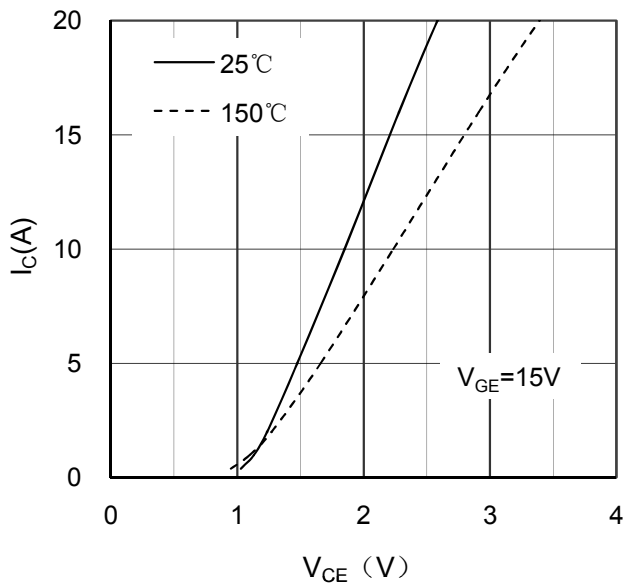

Figure 1. Typical Output Characteristics IGBT-inverter

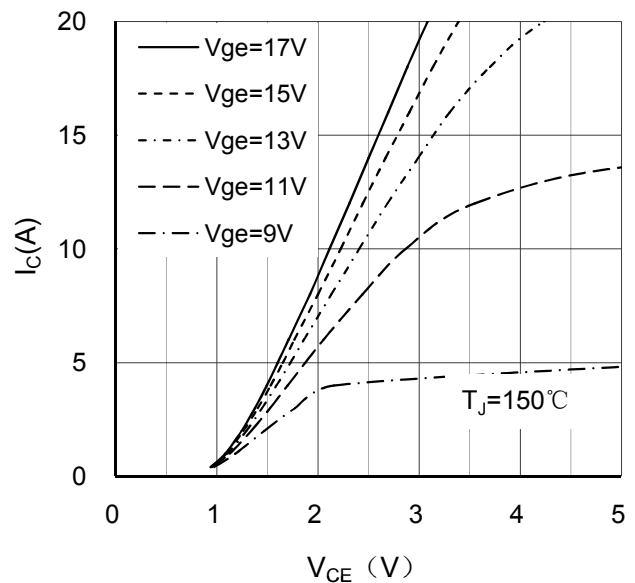

Figure 2. Typical Output Characteristics IGBT-inverter

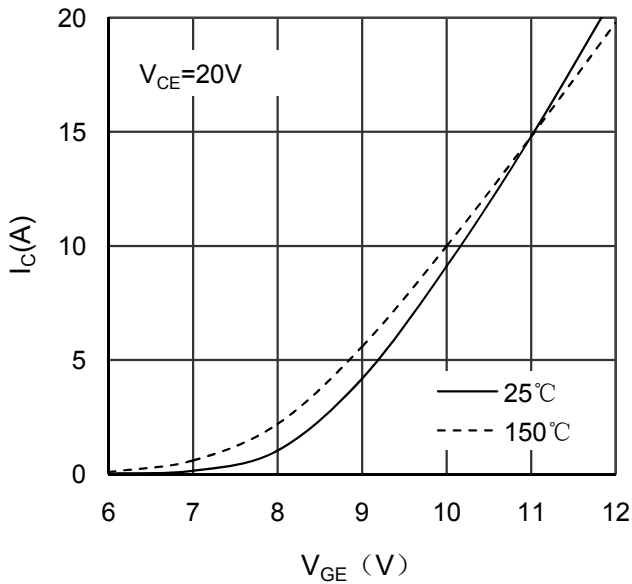

Figure 3. Typical Transfer characteristics IGBT-inverter

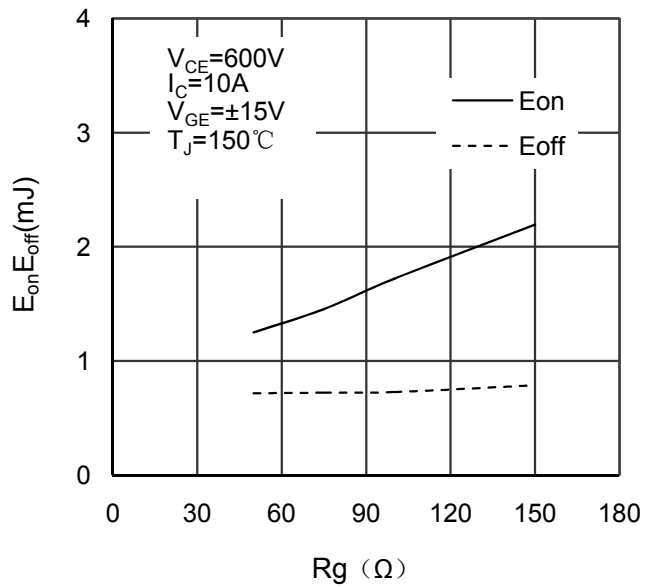

Figure 4. Switching Energy vs Gate Resistor IGBT-inverter

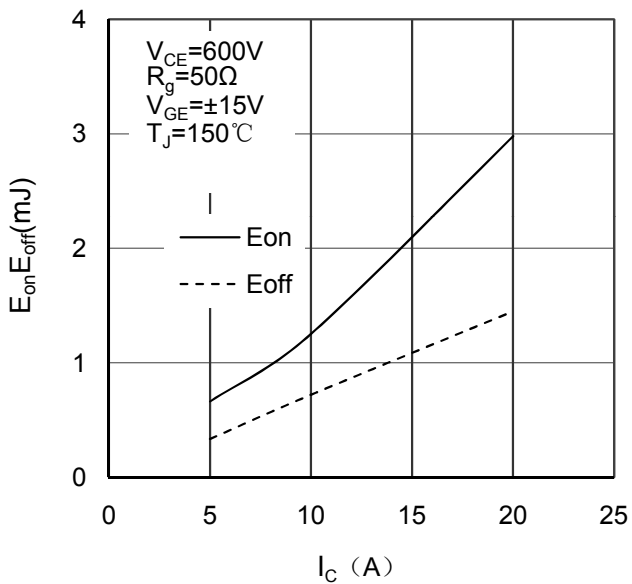

Figure 5. Switching Energy vs Collector Current IGBT-inverter

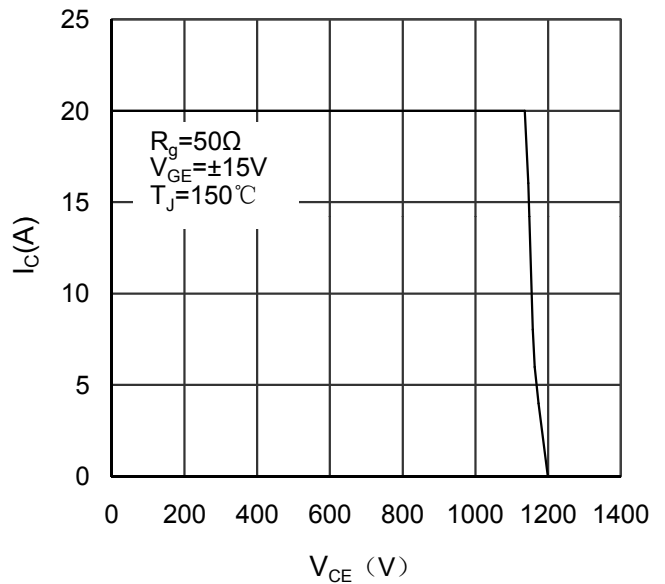

Figure 6. Reverse Biased Safe Operating Area IGBT-inverter

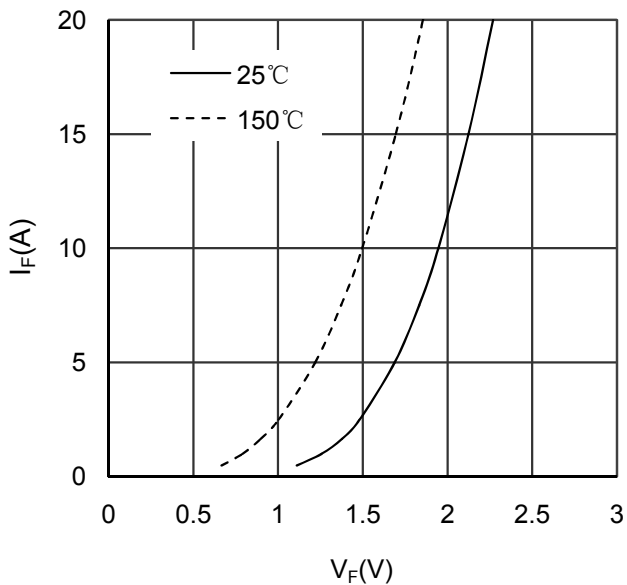

Figure 7. Diode Forward Characteristics Diode -inverter

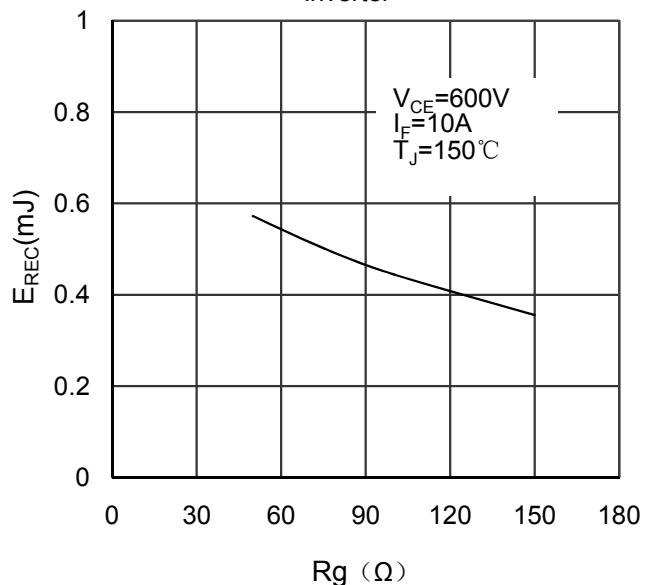

Figure 8. Switching Energy vs Gate Resistor Diode -inverter

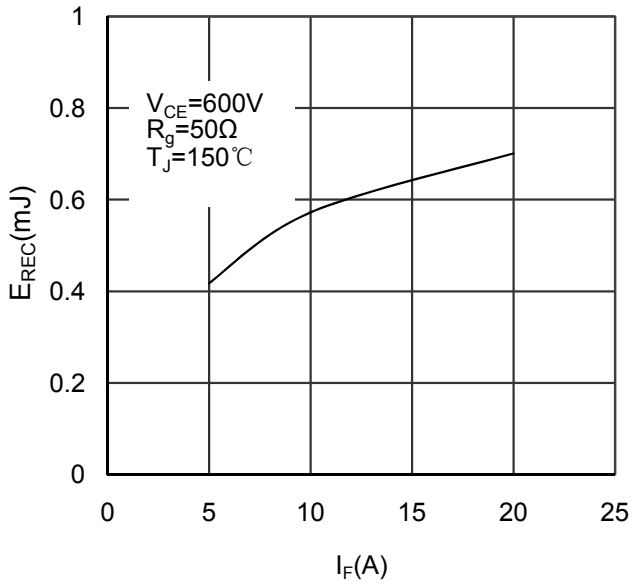

Figure 9. Switching Energy vs Forward Current Diode-inverter

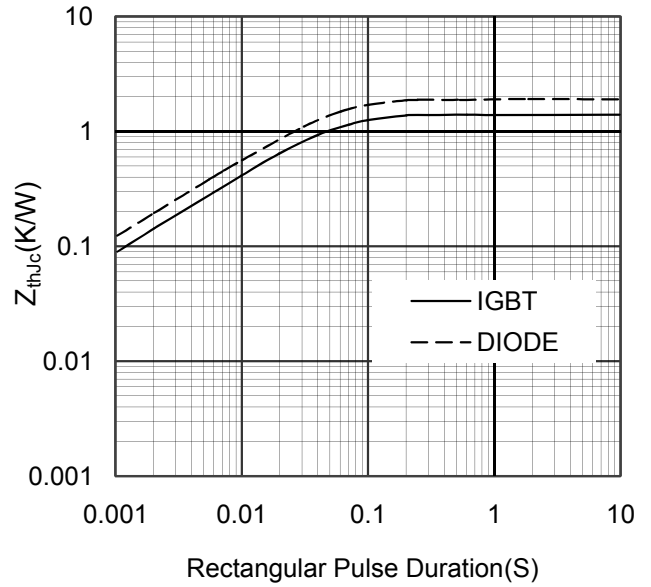

Figure 10. Transient Thermal Impedance of Diode and IGBT-inverter

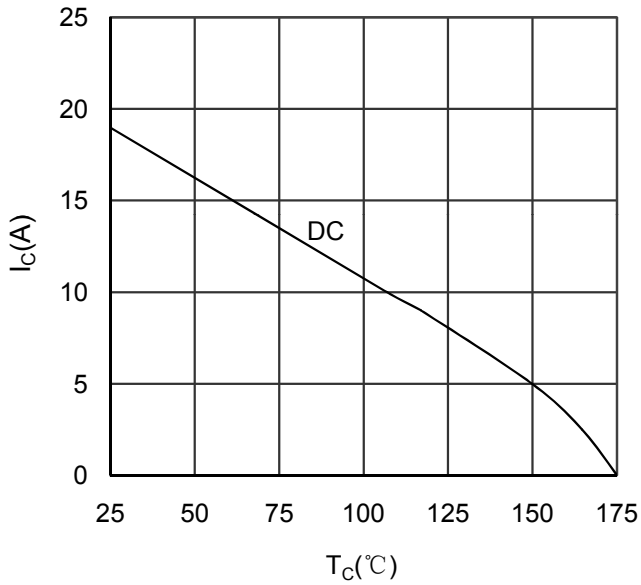

Figure 11. Collector Current vs Case temperature IGBT -inverter

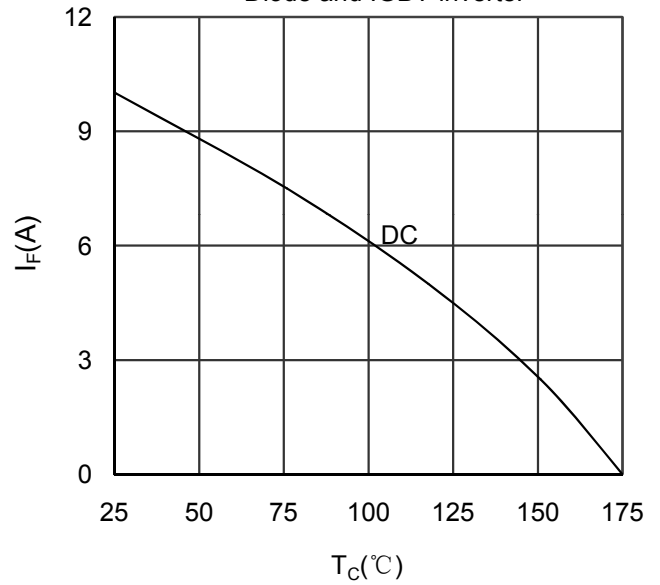

Figure 12. Forward current vs Case temperature Diode -inverter

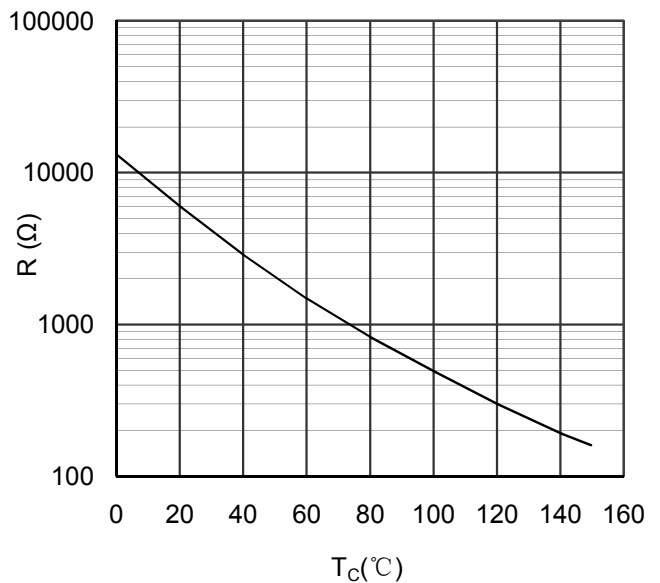

Figure 13. NTC Characteristics

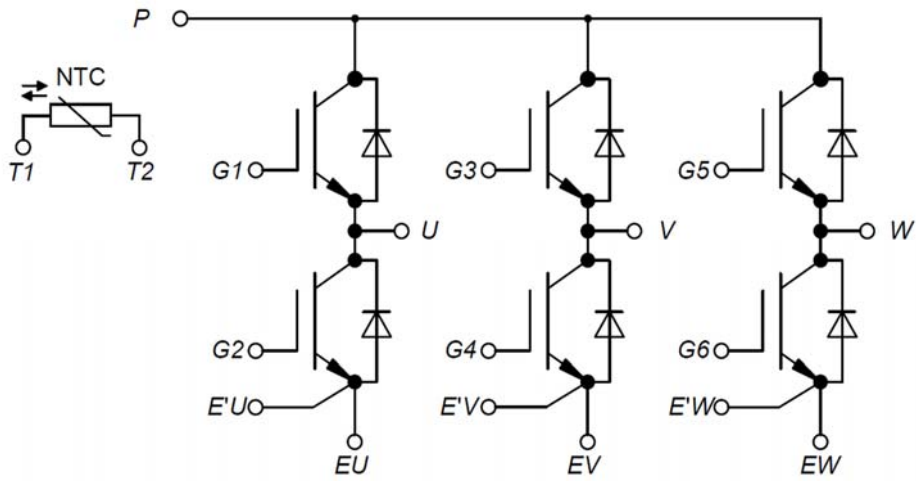
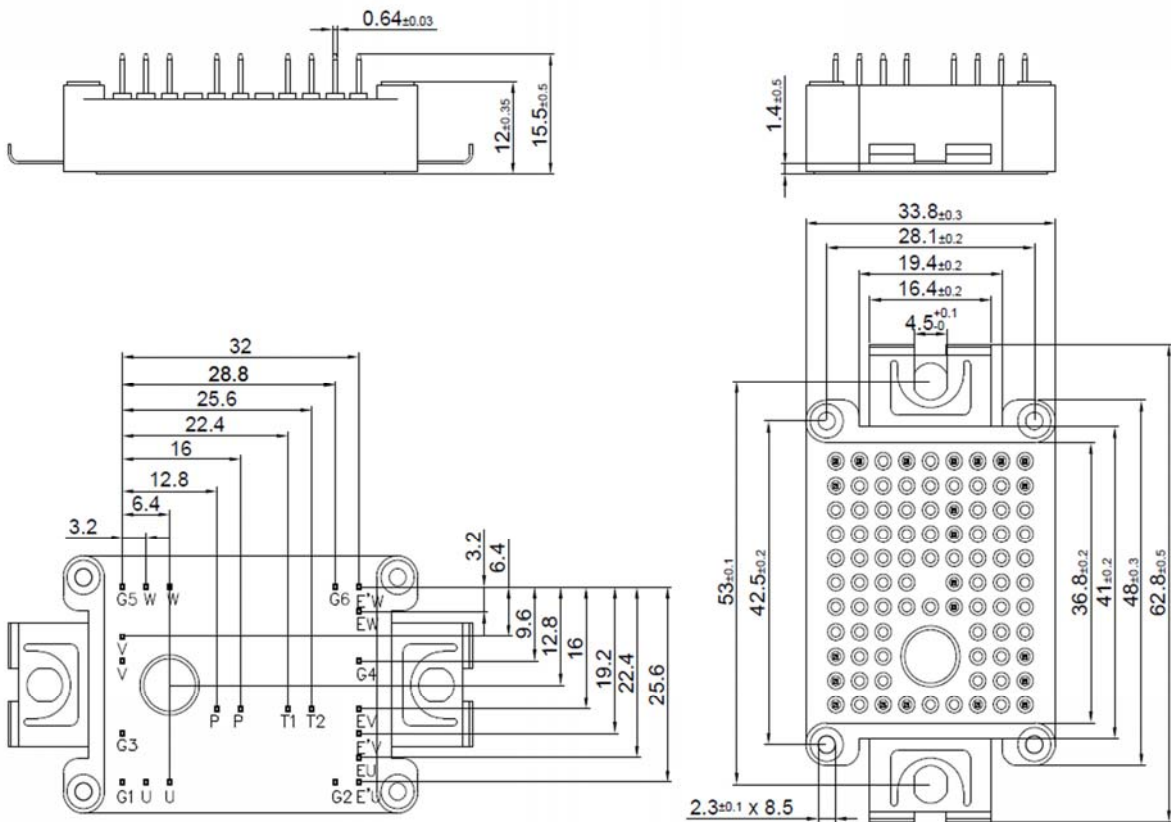

Figure 14. Circuit Diagram



Dimensions in (mm)

Figure 15. Package Outline