

PRODUCT FEATURES

- IGBT3 CHIP(1700V Trench+Field Stop technology)
- Low turn-off losses, short tail current
- $V_{CE(sat)}$ with positive temperature coefficient
- DIODE CHIP(1700V EMCON 3 technology)
- Free wheeling diodes with fast and soft reverse recovery
- Temperature sense included



APPLICATIONS

- AC motor control
- Motion/servo control
- Inverter and power supplies
- Photovoltaic/Fuel cell

IGBT-inverter

ABSOLUTE MAXIMUM RATINGS

$T_C=25^\circ\text{C}$ unless otherwise specified

Symbol	Parameter/Test Conditions		Values	Unit
V_{CES}	Collector Emitter Voltage	$T_J=25^\circ\text{C}$	1700	V
V_{GES}	Gate Emitter Voltage		± 20	
I_C	DC Collector Current	$T_C=25^\circ\text{C}$	400	A
		$T_C=95^\circ\text{C}$	300	
I_{CM}	Repetitive Peak Collector Current	$t_p=1\text{ms}$	600	
P_{tot}	Power Dissipation Per IGBT		2000	W

Diode-inverter

ABSOLUTE MAXIMUM RATINGS

$T_C=25^\circ\text{C}$ unless otherwise specified

Symbol	Parameter/Test Conditions		Values	Unit
V_{RRM}	Repetitive Reverse Voltage	$T_J=25^\circ\text{C}$	1700	V
$I_{F(AV)}$	Average Forward Current	$T_C=25^\circ\text{C}$	300	A
I_{FRM}	Repetitive Peak Forward Current	$t_p=1\text{ms}$	600	
i^2t		$T_J=125^\circ\text{C}$, $t=10\text{ms}$, $V_R=0\text{V}$	14500	A^2S

IGBT-inverter

ELECTRICAL CHARACTERISTICS

 $T_C=25^\circ\text{C}$ unless otherwise specified

Symbol	Parameter/Test Conditions		Min.	Typ.	Max.	Unit	
$V_{GE(th)}$	Gate Emitter Threshold Voltage		5.0	5.8	6.5	V	
$V_{CE(sat)}$	Collector Emitter Saturation Voltage	chip	$I_C=300\text{A}, V_{GE}=15\text{V}, T_J=25^\circ\text{C}$		2		2.45
			$I_C=300\text{A}, V_{GE}=15\text{V}, T_J=125^\circ\text{C}$		2.4		
I_{CES}	Collector Leakage Current		$V_{CE}=1700\text{V}, V_{GE}=0\text{V}, T_J=25^\circ\text{C}$		3	mA	
			$V_{CE}=1700\text{V}, V_{GE}=0\text{V}, T_J=125^\circ\text{C}$		20		
I_{GES}	Gate Leakage Current		-400		400	nA	
R_{gint}	Integrated Gate Resistor			2.5		Ω	
Q_g	Gate Charge		$V_{CE}=900\text{V}, I_C=300\text{A}, V_{GE}=\pm 15\text{V}$			μC	
C_{ies}	Input Capacitance		$V_{CE}=25\text{V}, V_{GE}=0\text{V}, f=1\text{MHz}$			27	nF
C_{res}	Reverse Transfer Capacitance					0.9	
$t_{d(on)}$	Turn on Delay Time		$V_{CC}=900\text{V}, I_C=300\text{A}$ $R_G=4.7\Omega,$ $V_{GE}=\pm 15\text{V},$ Inductive Load	$T_J=25^\circ\text{C}$	280	ns	
				$T_J=125^\circ\text{C}$	300		
t_r	Rise Time		$V_{CC}=900\text{V}, I_C=300\text{A}$ $R_G=4.7\Omega,$ $V_{GE}=\pm 15\text{V},$ Inductive Load	$T_J=25^\circ\text{C}$	70	ns	
				$T_J=125^\circ\text{C}$	85		
$t_{d(off)}$	Turn off Delay Time		$V_{CC}=900\text{V}, I_C=300\text{A}$ $R_G=4.7\Omega,$ $V_{GE}=\pm 15\text{V},$ Inductive Load	$T_J=25^\circ\text{C}$	810	ns	
				$T_J=125^\circ\text{C}$	1000		
t_f	Fall Time		$V_{CC}=900\text{V}, I_C=300\text{A}$ $R_G=4.7\Omega,$ $V_{GE}=\pm 15\text{V},$ Inductive Load	$T_J=25^\circ\text{C}$	180	ns	
				$T_J=125^\circ\text{C}$	300		
E_{on}	Turn on Energy		$V_{CC}=900\text{V}, I_C=300\text{A}$ $R_G=4.7\Omega,$ $V_{GE}=\pm 15\text{V},$ Inductive Load	$T_J=25^\circ\text{C}$	65.5	mJ	
				$T_J=125^\circ\text{C}$	95		
E_{off}	Turn off Energy		$V_{CC}=900\text{V}, I_C=300\text{A}$ $R_G=4.7\Omega,$ $V_{GE}=\pm 15\text{V},$ Inductive Load	$T_J=25^\circ\text{C}$	64	mJ	
				$T_J=125^\circ\text{C}$	94		
I_{sc}	Short Circuit Current		$t_{psc} \leq 10\mu\text{s}, V_{GE}=15\text{V}$ $T_J=125^\circ\text{C}, V_{CC}=1000\text{V}$		1200	A	
R_{thJC}	Junction to Case Thermal Resistance (Per IGBT)				0.075	K/W	

Diode-inverter

ELECTRICAL CHARACTERISTICS

 $T_C=25^\circ\text{C}$ unless otherwise specified

Symbol	Parameter/Test Conditions		Min.	Typ.	Max.	Unit
V_F	Forward Voltage	chip	$I_F=300\text{A}, V_{GE}=0\text{V}, T_J=25^\circ\text{C}$		1.8	2.2
			$I_F=300\text{A}, V_{GE}=0\text{V}, T_J=125^\circ\text{C}$		1.9	
I_{RRM}	Max. Reverse Recovery Current		$I_F=300\text{A}, V_R=900\text{V}$		380	A
Q_{RR}	Reverse Recovery Charge		$di_F/dt=-3600\text{A}/\mu\text{s}$ $T_J=125^\circ\text{C}$		130	μC
E_{rec}	Reverse Recovery Energy		$T_J=125^\circ\text{C}$		71.5	mJ
R_{thJCD}	Junction to Case Thermal Resistance (Per Diode)				0.13	K/W

NTC CHARACTERISTICS

 $T_C=25^\circ\text{C}$ unless otherwise specified

Symbol	Parameter/Test Conditions		Min.	Typ.	Max.	Unit
R_{25}	Resistance		$T_C=25^\circ\text{C}$		5	K Ω
$B_{25/50}$	$R_2 = R_{25} \exp [B_{25/50}(1/T_2 - 1/(298.15 \text{ K}))]$			3375		K

MODULE CHARACTERISTICS

T_C=25°C unless otherwise specified

Symbol	Parameter/Test Conditions		Values	Unit
T _{Jmax}	Max. Junction Temperature		175	°C
T _{Jop}	Operating Temperature		-40~150	
T _{stg}	Storage Temperature		-40~125	
V _{isol}	Isolation Breakdown Voltage	AC, 50Hz(R.M.S), t=1minute	4000	V
CTI	Comparative Tracking Index		> 225	
Torque	to heatsink	Recommended (M5)	2.5~5	Nm
	to terminal	Recommended (M6)	3~5	Nm
Weight			350	g

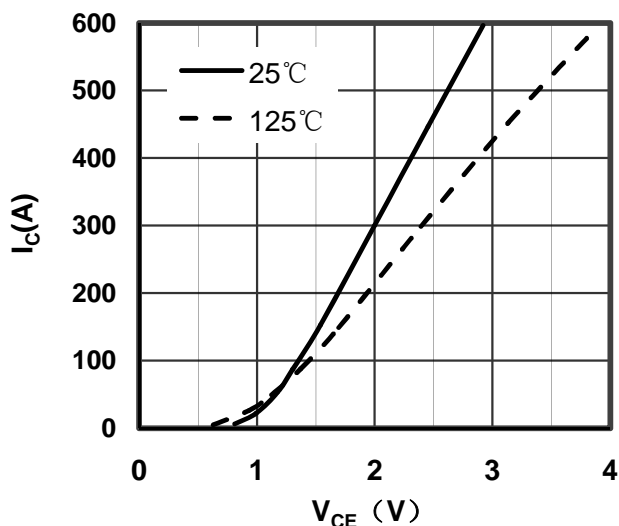

Figure 1. Typical Output Characteristics IGBT-inverter

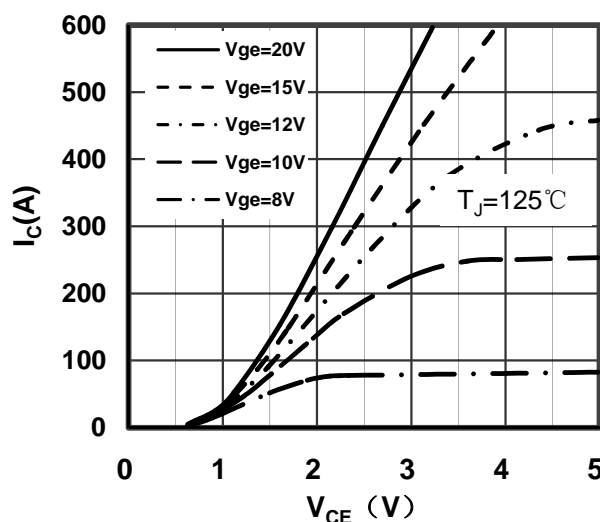

Figure 2. Typical Output Characteristics IGBT-inverter

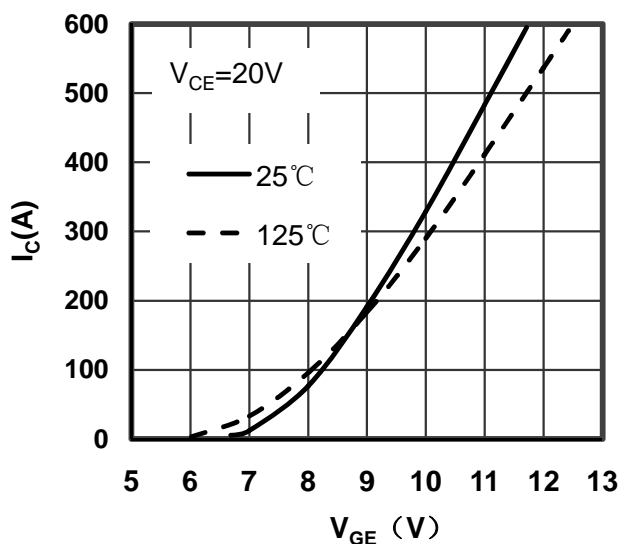

Figure 3. Typical Transfer Characteristics IGBT-inverter

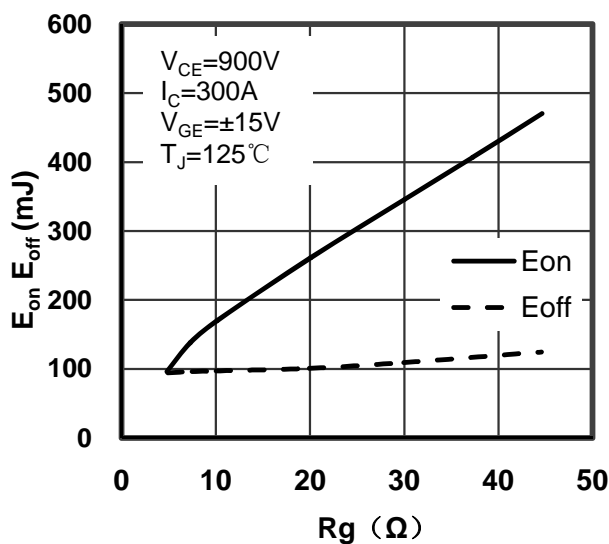

Figure 4. Switching Energy vs Gate Resistor IGBT-inverter

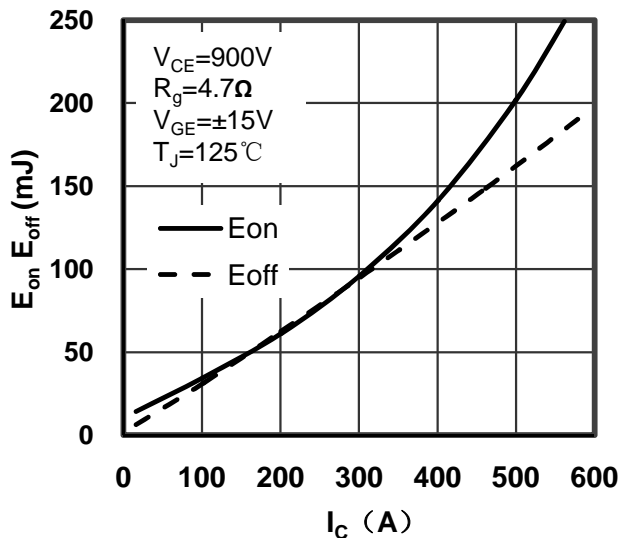

Figure 5. Switching Energy vs Collector Current IGBT-inverter

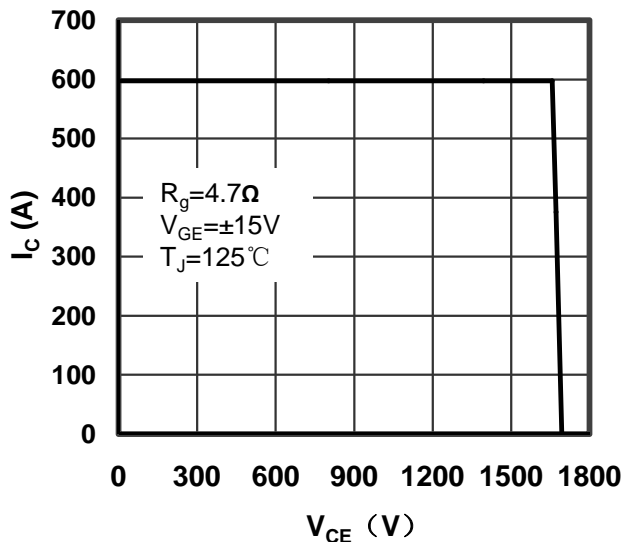

Figure 6. Reverse Biased Safe Operating Area IGBT-inverter

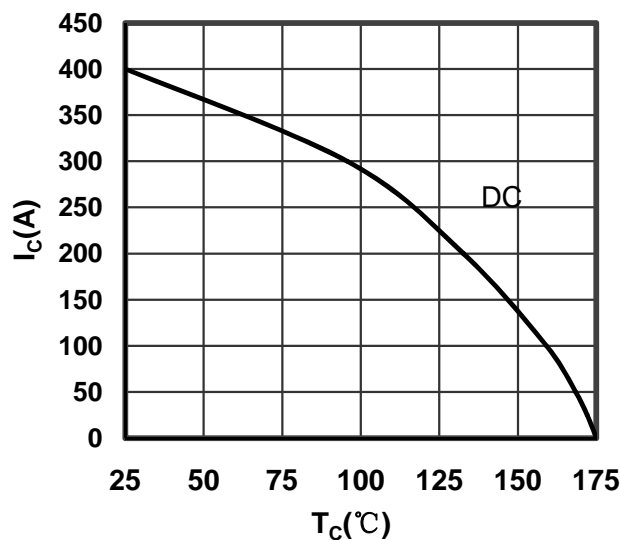

Figure 7. Collector Current vs Case temperature IGBT-inverter

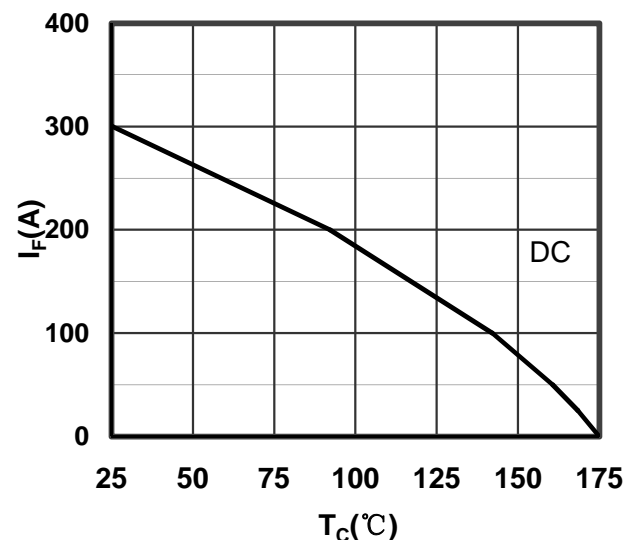

Figure 8. Forward current vs Case temperature Diode-inverter

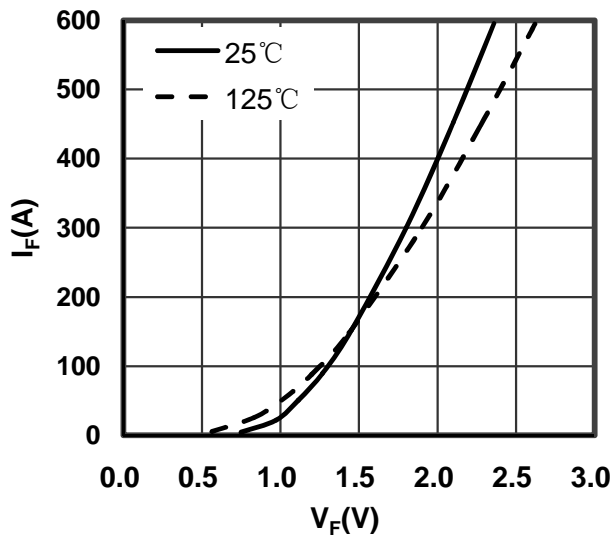

Figure 9. Diode Forward Characteristics Diode-inverter

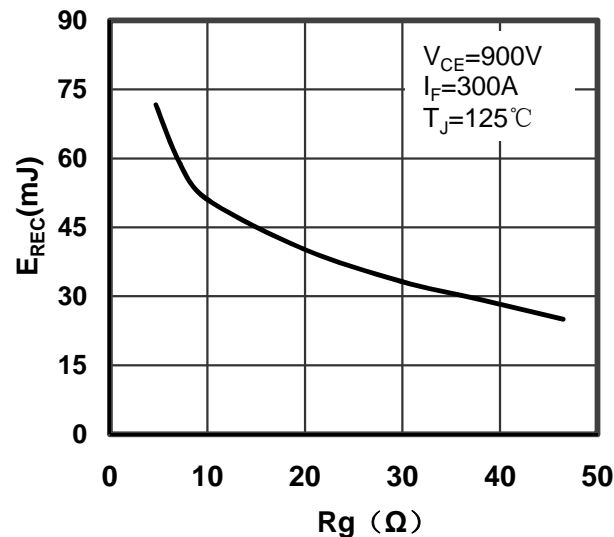

Figure 10. Switching Energy vs Gate Resistor Diode-inverter

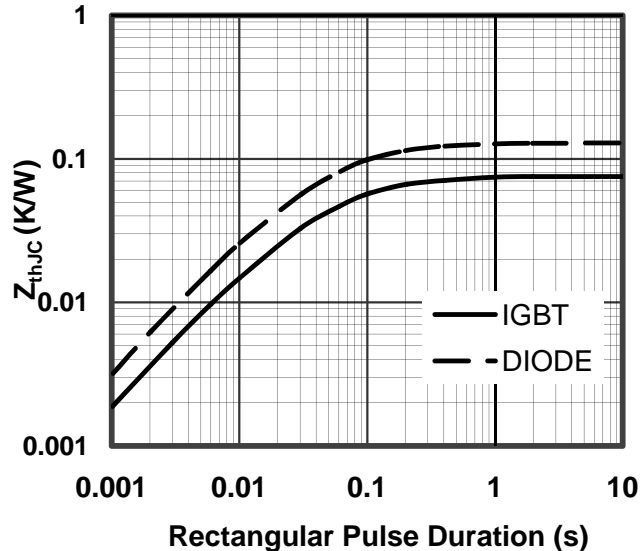
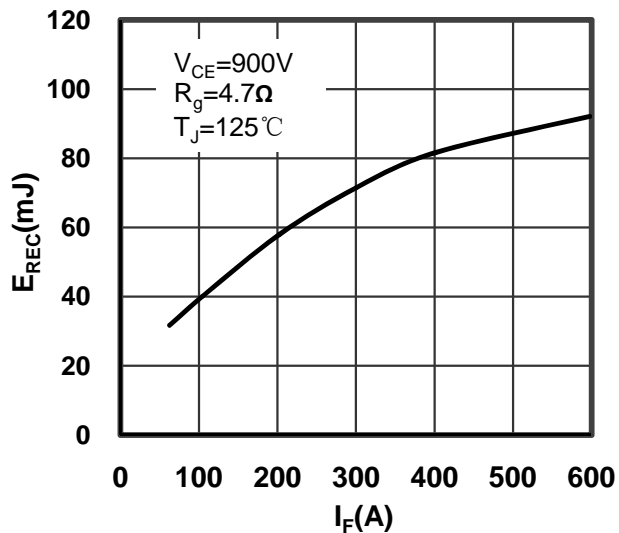

Figure 11. Switching Energy vs Forward Current Diode-inverter

Figure 12. Transient Thermal Impedance of Diode and IGBT-inverter

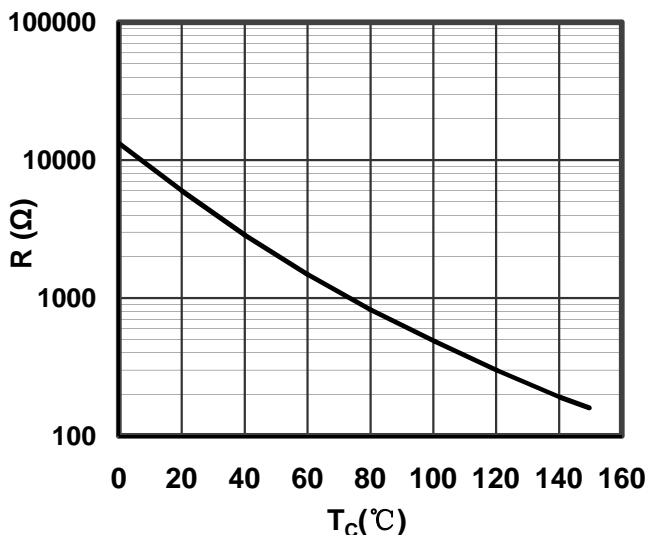

Figure 13. NTC Characteristics

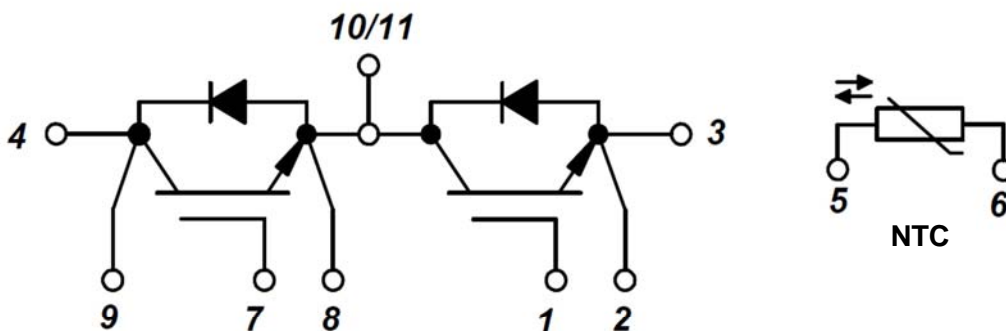
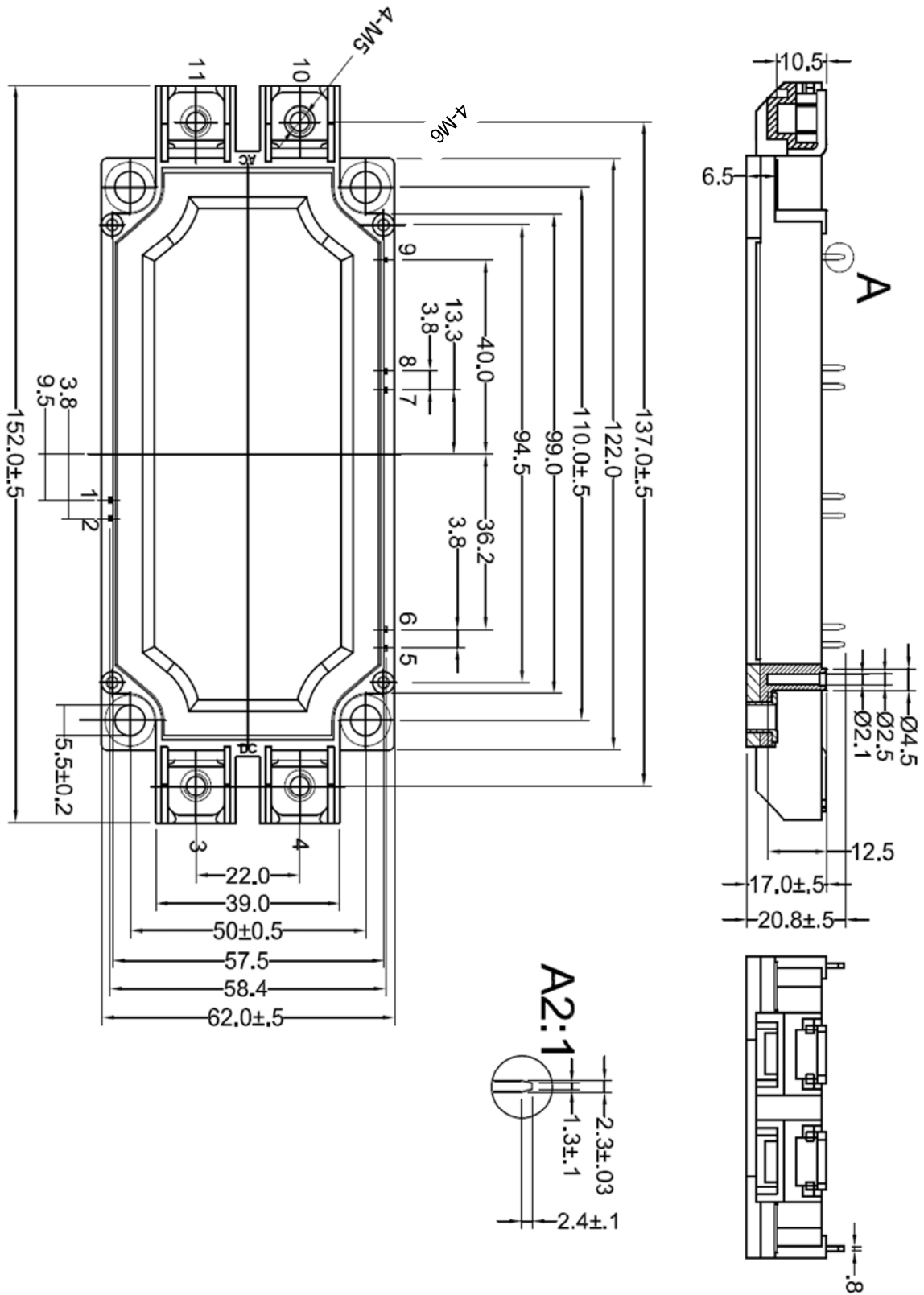

Figure 14. Circuit Diagram



Dimensions in (mm)
Figure 15. Package Outline