

PRODUCT FEATURES

- High level of integration
- IGBT CHIP(Trench+Field Stop technology)
- Low saturation voltage and positive temperature coefficient
- Fast switching and short tail current
- Free wheeling diodes with fast and soft reverse recovery
- Industry standard package with insulated copper base plate and soldering pins for PCB mounting
- Temperature sense included

APPLICATIONS

- AC motor control
- Motion/servo control
- Inverter and power supplies

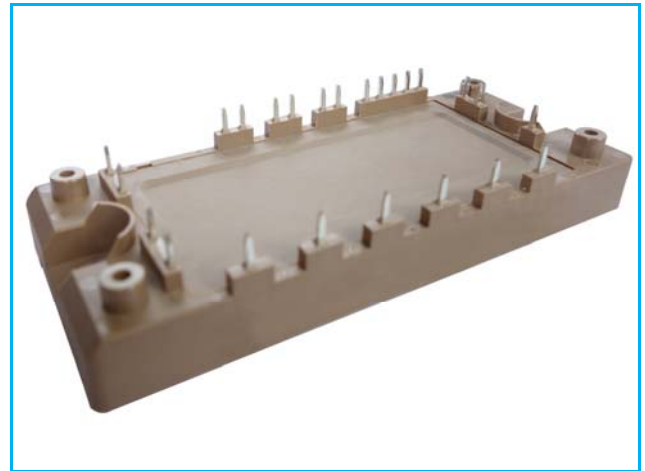

Rectifier+Brake+Inverter

IGBT-inverter

ABSOLUTE MAXIMUM RATINGS ($T_C=25^{\circ}\text{C}$ unless otherwise specified)

Symbol	Parameter/Test Conditions		Values	Unit
V_{CES}	Collector Emitter Voltage	$T_J=25^{\circ}\text{C}$	1200	V
V_{GES}	Gate Emitter Voltage		± 20	
I_C	DC Collector Current	$T_C=25^{\circ}\text{C}, T_{Jmax}=175^{\circ}\text{C}$	55	A
		$T_C=85^{\circ}\text{C}, T_{Jmax}=175^{\circ}\text{C}$	40	
I_{CM}	Repetitive Peak Collector Current	$t_p=1\text{ms}$	80	
P_{tot}	Power Dissipation Per IGBT	$T_C=25^{\circ}\text{C}, T_{Jmax}=175^{\circ}\text{C}$	208	W

Diode-inverter

ABSOLUTE MAXIMUM RATINGS ($T_C=25^{\circ}\text{C}$ unless otherwise specified)

Symbol	Parameter/Test Conditions		Values	Unit
V_{RRM}	Repetitive Reverse Voltage	$T_J=25^{\circ}\text{C}$	1200	V
$I_{F(AV)}$	Average Forward Current		40	A
I_{FRM}	Repetitive Peak Forward Current	$t_p=1\text{ms}$	80	
I^2t		$T_J=125^{\circ}\text{C}, t=10\text{ms}, V_R=0\text{V}$	250	A^2S

MacMic Science & Technology Co., Ltd.

Add: #18, Hua Shan Zhong Lu, New District, Changzhou City, Jiangsu Province, P. R .of China

Tel.: +86-519-85163708 Fax: +86-519-85162291 Post Code: 213022 Website: www.macmicst.com

MMG40H120XB6TC

IGBT-inverter

ELECTRICAL CHARACTERISTICS ($T_C=25^\circ\text{C}$ unless otherwise specified)

Symbol	Parameter/Test Conditions		Min.	Typ.	Max.	Unit
$V_{GE(th)}$	Gate Emitter Threshold Voltage	$V_{CE}=V_{GE}, I_C=1.6\text{mA}$	5.0	5.8	6.5	V
$V_{CE(sat)}$	Collector Emitter Saturation Voltage	$I_C=40\text{A}, V_{GE}=15\text{V}, T_J=25^\circ\text{C}$		1.95	2.35	
		$I_C=40\text{A}, V_{GE}=15\text{V}, T_J=125^\circ\text{C}$		2.3		
		$I_C=40\text{A}, V_{GE}=15\text{V}, T_J=150^\circ\text{C}$		2.4		
I_{CES}	Collector Leakage Current	$V_{CE}=1200\text{V}, V_{GE}=0\text{V}, T_J=25^\circ\text{C}$			1	mA
		$V_{CE}=1200\text{V}, V_{GE}=0\text{V}, T_J=150^\circ\text{C}$			10	
I_{GES}	Gate Leakage Current	$V_{CE}=0\text{V}, V_{GE}=\pm 15\text{V}, T_J=25^\circ\text{C}$	-400		400	nA
R_{gint}	Integrated Gate Resistor			0		Ω
Q_g	Gate Charge	$V_{CE}=600\text{V}, I_C=40\text{A}, V_{GE}=15\text{V}$		0.22		nC
C_{ies}	Input Capacitance	$V_{CE}=25\text{V}, V_{GE}=0\text{V}, f=1\text{MHz}$		2.8		nF
C_{res}	Reverse Transfer Capacitance				110	
$t_{d(on)}$	Turn on Delay Time	$V_{CC}=600\text{V}, I_C=40\text{A}$ $R_G=20\Omega,$	$T_J=25^\circ\text{C}$		20	ns
			$T_J=125^\circ\text{C}$		25	ns
			$T_J=150^\circ\text{C}$		30	ns
t_r	Rise Time	$V_{GE}=\pm 15\text{V},$ Inductive Load	$T_J=25^\circ\text{C}$		40	ns
			$T_J=125^\circ\text{C}$		45	ns
			$T_J=150^\circ\text{C}$		45	ns
$t_{d(off)}$	Turn off Delay Time	$V_{CC}=600\text{V}, I_C=40\text{A}$ $R_G=20\Omega,$	$T_J=25^\circ\text{C}$		180	ns
			$T_J=125^\circ\text{C}$		220	ns
			$T_J=150^\circ\text{C}$		240	ns
t_f	Fall Time	$V_{GE}=\pm 15\text{V},$ Inductive Load	$T_J=25^\circ\text{C}$		170	ns
			$T_J=125^\circ\text{C}$		200	ns
			$T_J=150^\circ\text{C}$		220	ns
E_{on}	Turn on Energy	$V_{CC}=600\text{V}, I_C=40\text{A}$ $R_G=20\Omega,$	$T_J=125^\circ\text{C}$		5.4	mJ
			$T_J=150^\circ\text{C}$		5.8	mJ
E_{off}	Turn off Energy	$V_{GE}=\pm 15\text{V},$ Inductive Load	$T_J=125^\circ\text{C}$		3.35	mJ
			$T_J=150^\circ\text{C}$		3.55	mJ
I_{SC}	Short Circuit Current	$t_{psc} \leq 10\mu\text{s}, V_{GE}=15\text{V}$ $T_J=150^\circ\text{C}, V_{CC}=600\text{V}$		145		A
R_{thJC}	Junction to Case Thermal Resistance (Per IGBT)				0.72	K/W

Diode-inverter

ELECTRICAL CHARACTERISTICS ($T_C=25^\circ\text{C}$ unless otherwise specified)

Symbol	Parameter/Test Conditions		Min.	Typ.	Max.	Unit
V_F	Forward Voltage	$I_F=40\text{A}, V_{GE}=0\text{V}, T_J=25^\circ\text{C}$		1.85	2.3	V
		$I_F=40\text{A}, V_{GE}=0\text{V}, T_J=125^\circ\text{C}$		1.65		
		$I_F=40\text{A}, V_{GE}=0\text{V}, T_J=150^\circ\text{C}$		1.60		
t_{rr}	Reverse Recovery Time	$I_F=40\text{A}, V_R=600\text{V}$ $dI_F/dt=-1000\text{A}/\mu\text{s}$ $T_J=150^\circ\text{C}$		350		ns
I_{RRM}	Max. Reverse Recovery Current			45		A
Q_{RR}	Reverse Recovery Charge			6.5		μC
E_{rec}	Reverse Recovery Energy			2		mJ
R_{thJCD}	Junction to Case Thermal Resistance (Per Diode)				1.05	K/W

MMG40H120XB6TC

Diode-RECTIFIER

ABSOLUTE MAXIMUM RATINGS ($T_C=25^\circ\text{C}$ unless otherwise specified)

Symbol	Parameter/Test Conditions		Values	Unit
V_{RRM}	Repetitive Reverse Voltage	$T_J=25^\circ\text{C}$	1600	V
$I_{F(AV)}$	Average Forward Current Per Diode	$T_C=80^\circ\text{C}$	50	A
I_{FRMS}	R.M.S. Forward Current Per Diode		75	
I_{RMS}	R.M.S. Current at rectifier output		80	
I_{FSM}	Non Repetitive Surge Forward Current	$T_J=45^\circ\text{C}$, $t=10\text{ms}$, 50Hz	480	
		$T_J=45^\circ\text{C}$, $t=8.3\text{ms}$, 60Hz	527	
I^2t		$T_J=45^\circ\text{C}$, $t=10\text{ms}$, 50Hz	1152	A ² S
		$T_J=45^\circ\text{C}$, $t=8.3\text{ms}$, 60Hz	1152	

Diode-RECTIFIER

ELECTRICAL CHARACTERISTICS ($T_C=25^\circ\text{C}$ unless otherwise specified)

Symbol	Parameter/Test Conditions		Min.	Typ.	Max.	Unit
V_F	Forward Voltage	$I_F=40\text{A}$, $T_J=25^\circ\text{C}$		1.06	1.2	V
		$I_F=40\text{A}$, $T_J=150^\circ\text{C}$		1.00		V
I_R	Reverse Leakage Current	$V_R=1600\text{V}$, $T_J=25^\circ\text{C}$			50	μA
		$V_R=1600\text{V}$, $T_J=150^\circ\text{C}$			1	mA
R_{thJCD}	Junction to Case Thermal Resistance (Per Diode)				0.8	K /W

IGBT-Brake chopper

ABSOLUTE MAXIMUM RATINGS ($T_C=25^\circ\text{C}$ unless otherwise specified)

Symbol	Parameter/Test Conditions		Values	Unit
V_{CES}	Collector Emitter Voltage	$T_J=25^\circ\text{C}$	1200	V
V_{GES}	Gate Emitter Voltage		± 20	
I_C	DC Collector Current	$T_C=25^\circ\text{C}$, $T_{Jmax}=175^\circ\text{C}$	39	A
		$T_C=100^\circ\text{C}$, $T_{Jmax}=175^\circ\text{C}$	25	
I_{CM}	Repetitive Peak Collector Current	$t_p=1\text{ms}$	50	
P_{tot}	Power Dissipation Per IGBT	$T_C=25^\circ\text{C}$, $T_{Jmax}=175^\circ\text{C}$	166	W

Diode-Brake chopper

ABSOLUTE MAXIMUM RATINGS ($T_C=25^\circ\text{C}$ unless otherwise specified)

Symbol	Parameter/Test Conditions		Values	Unit
V_{RRM}	Repetitive Reverse Voltage	$T_J=25^\circ\text{C}$	1200	V
$I_{F(AV)}$	Average Forward Current		15	A
I_{FRM}	Repetitive Peak Forward Current	$t_p=1\text{ms}$	30	
I^2t		$T_J=125^\circ\text{C}$, $t=10\text{ms}$, $V_R=0\text{V}$	48	A ² S

MMG40H120XB6TC

IGBT-Brake chopper

ELECTRICAL CHARACTERISTICS ($T_C=25^\circ\text{C}$ unless otherwise specified)

Symbol	Parameter/Test Conditions		Min.	Typ.	Max.	Unit
$V_{GE(th)}$	Gate Emitter Threshold Voltage	$V_{CE}=V_{GE}, I_C=0.8\text{mA}$	5.0	5.8	6.5	V
$V_{CE(sat)}$	Collector - Emitter Saturation Voltage	$I_C=25\text{A}, V_{GE}=15\text{V}, T_J=25^\circ\text{C}$		1.85	2.25	
		$I_C=25\text{A}, V_{GE}=15\text{V}, T_J=125^\circ\text{C}$		2.15		
		$I_C=25\text{A}, V_{GE}=15\text{V}, T_J=150^\circ\text{C}$		2.25		
I_{CES}	Collector Leakage Current	$V_{CE}=1200\text{V}, V_{GE}=0\text{V}, T_J=25^\circ\text{C}$			1	mA
		$V_{CE}=1200\text{V}, V_{GE}=0\text{V}, T_J=150^\circ\text{C}$			10	
I_{GES}	Gate Leakage Current	$V_{CE}=0\text{V}, V_{GE}=\pm 15\text{V}, T_J=25^\circ\text{C}$	-400		400	nA
R_{gint}	Integrated Gate Resistor			0		Ω
Q_g	Gate Charge	$V_{CE}=600\text{V}, I_C=25\text{A}, V_{GE}=15\text{V}$		0.15		μC
C_{ies}	Input Capacitance	$V_{CE}=25\text{V}, V_{GE}=0\text{V}, f=1\text{MHz}$		1.9		nF
C_{res}	Reverse Transfer Capacitance				85	
$t_{d(on)}$	Turn on Delay Time	$V_{CC}=600\text{V}, I_C=25\text{A}$ $R_G=30\Omega,$	$T_J=25^\circ\text{C}$		30	ns
			$T_J=125^\circ\text{C}$		40	ns
			$T_J=150^\circ\text{C}$		40	ns
t_r	Rise Time	$V_{GE}=\pm 15\text{V},$ Inductive Load	$T_J=25^\circ\text{C}$		35	ns
			$T_J=125^\circ\text{C}$		40	ns
			$T_J=150^\circ\text{C}$		40	ns
$t_{d(off)}$	Turn off Delay Time	$V_{CC}=600\text{V}, I_C=25\text{A}$ $R_G=30\Omega,$	$T_J=25^\circ\text{C}$		210	ns
			$T_J=125^\circ\text{C}$		250	ns
			$T_J=150^\circ\text{C}$		270	ns
t_f	Fall Time	$V_{GE}=\pm 15\text{V},$ Inductive Load	$T_J=25^\circ\text{C}$		190	ns
			$T_J=125^\circ\text{C}$		210	ns
			$T_J=150^\circ\text{C}$		230	ns
E_{on}	Turn on Energy	$V_{CC}=600\text{V}, I_C=25\text{A}$ $R_G=30\Omega,$	$T_J=125^\circ\text{C}$		3.5	mJ
			$T_J=150^\circ\text{C}$		3.7	mJ
E_{off}	Turn off Energy	$V_{GE}=\pm 15\text{V},$ Inductive Load	$T_J=125^\circ\text{C}$		2.4	mJ
			$T_J=150^\circ\text{C}$		2.55	mJ
I_{SC}	Short Circuit Current	$t_{psc}\leq 10\mu\text{S}, V_{GE}=15\text{V}$ $T_J=150^\circ\text{C}, V_{CC}=600\text{V}$		100		A
R_{thJC}	Junction to Case Thermal Resistance (Per IGBT)				0.9	K/W

Diode-Brake chopper

ELECTRICAL CHARACTERISTICS ($T_C=25^\circ\text{C}$ unless otherwise specified)

Symbol	Parameter/Test Conditions		Min.	Typ.	Max.	Unit
V_F	Forward Voltage	$I_F=15\text{A}, V_{GE}=0\text{V}, T_J=25^\circ\text{C}$		1.75	2.25	V
		$I_F=15\text{A}, V_{GE}=0\text{V}, T_J=150^\circ\text{C}$		1.75		
t_{rr}	Reverse Recovery Time	$I_F=15\text{A}, V_R=600\text{V}$ $dI_F/dt=-550\text{A}/\mu\text{s}$ $T_J=150^\circ\text{C}$		330		ns
I_{RRM}	Max. Reverse Recovery Current			24		A
Q_{RR}	Reverse Recovery Charge			3.2		μC
E_{rec}	Reverse Recovery Energy			1.2		mJ
R_{thJCD}	Junction to Case Thermal Resistance (Per Diode)				1.5	K/W

MMG40H120XB6TC

NTC CHARACTERISTICS ($T_C=25^\circ\text{C}$ unless otherwise specified)

Symbol	Parameter/Test Conditions	Min.	Typ.	Max.	Unit
R_{25}	Resistance $T_C = 25^\circ\text{C}$		5		$\text{K}\Omega$
$B_{25/50}$	$R_2 = R_{25} \exp [B_{25/50}(1/T_2 - 1/(298.15 \text{ K}))]$		3375		K

MODULE CHARACTERISTICS ($T_C=25^\circ\text{C}$ unless otherwise specified)

Symbol	Parameter/Test Conditions	Values	Unit
T_{Jmax}	Max. Junction Temperature	Inverter, Brake-Chopper	175
		Rectifier	150
T_{Jop}	Operating Temperature	-40~150	$^\circ\text{C}$
T_{stg}	Storage Temperature	-40~125	$^\circ\text{C}$
V_{isol}	Isolation Breakdown Voltage	AC, 50Hz(R.M.S), t=1minute	3000
CTI	Comparative Tracking Index		>200
Md	Mounting Torque	Recommended (M5)	2.5~5
Weight			180

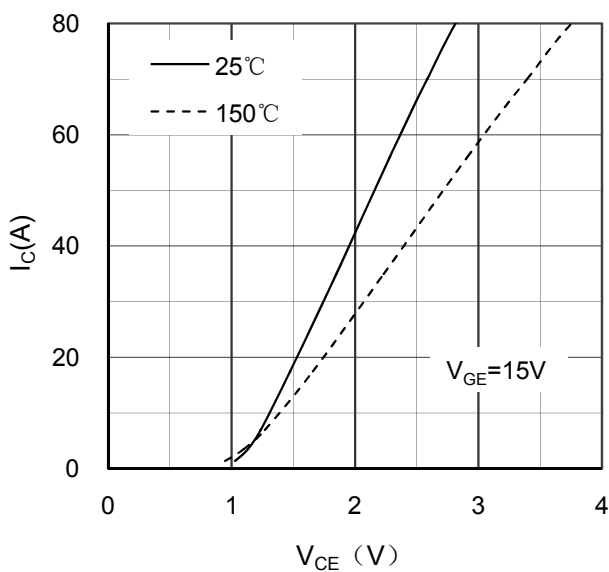

Figure 1. Typical Output Characteristics IGBT-inverter

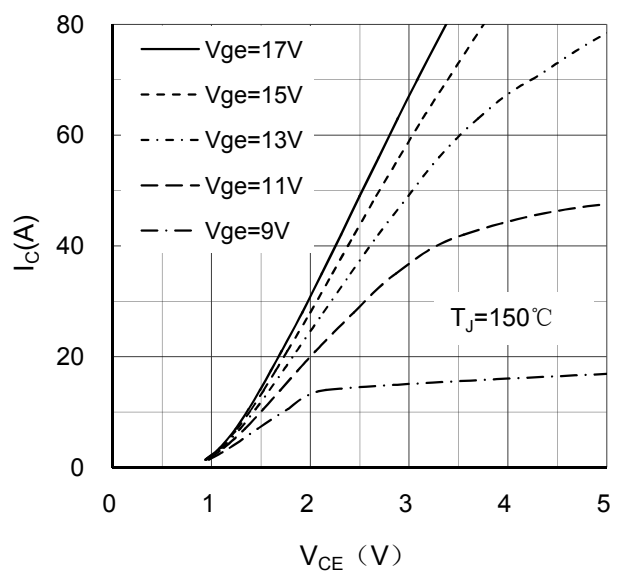

Figure 2. Typical Output Characteristics IGBT-inverter

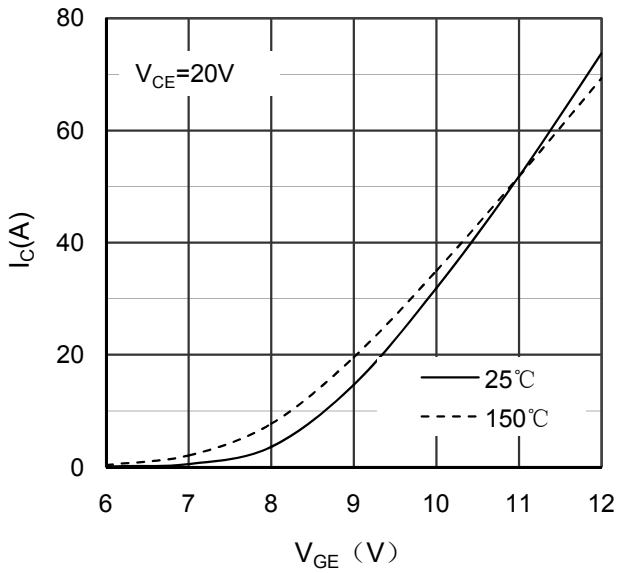

Figure 3. Typical Transfer characteristics IGBT-inverter

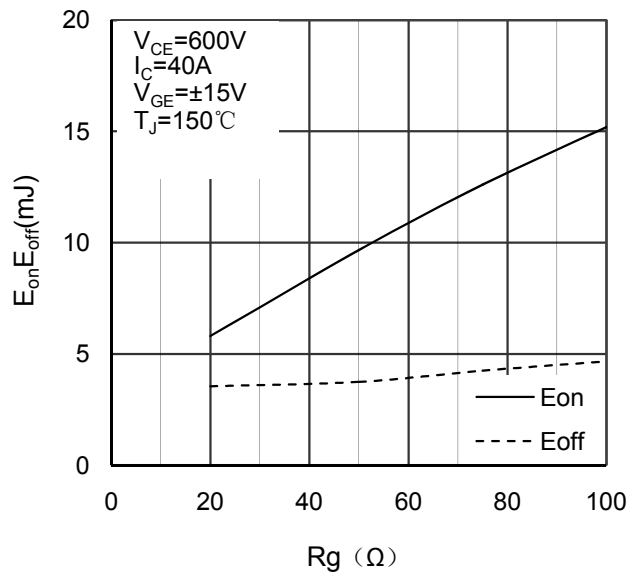

Figure 4. Switching Energy vs Gate Resistor IGBT-inverter

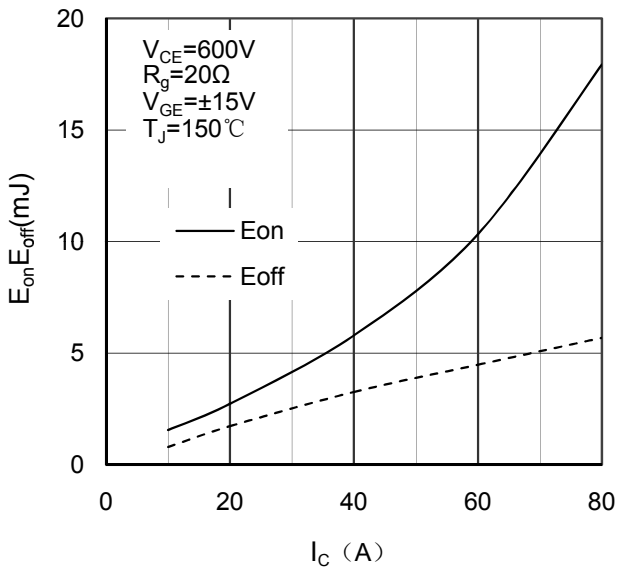

Figure 5. Switching Energy vs Collector Current IGBT-inverter

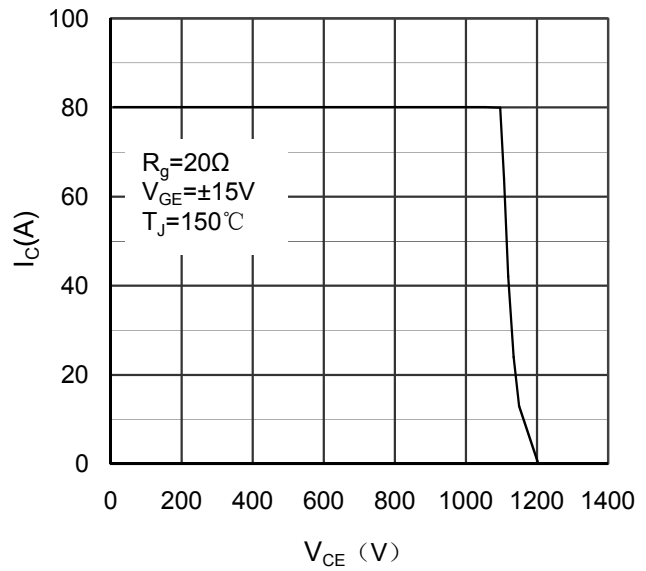

Figure 6. Reverse Biased Safe Operating Area IGBT-inverter

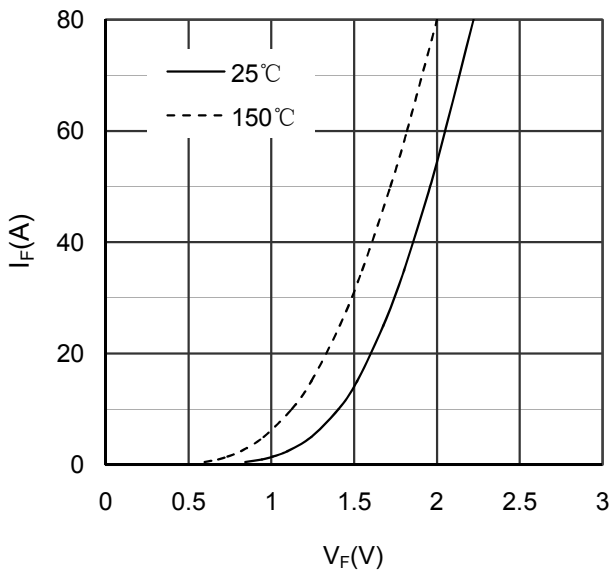

Figure 7. Diode Forward Characteristics Diode -inverter

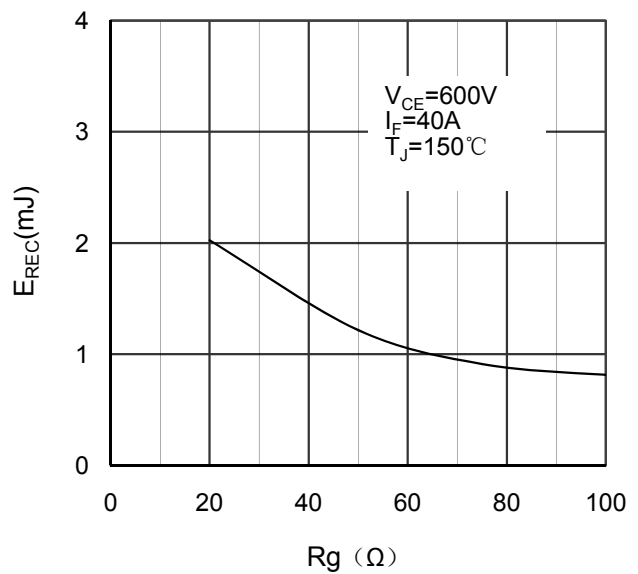

Figure 8. Switching Energy vs Gate Resistor Diode -inverter

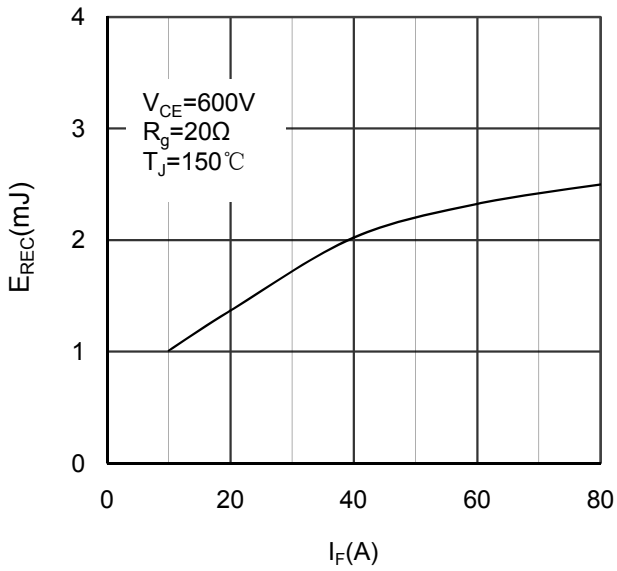

Figure 9. Switching Energy vs Forward Current Diode-inverter

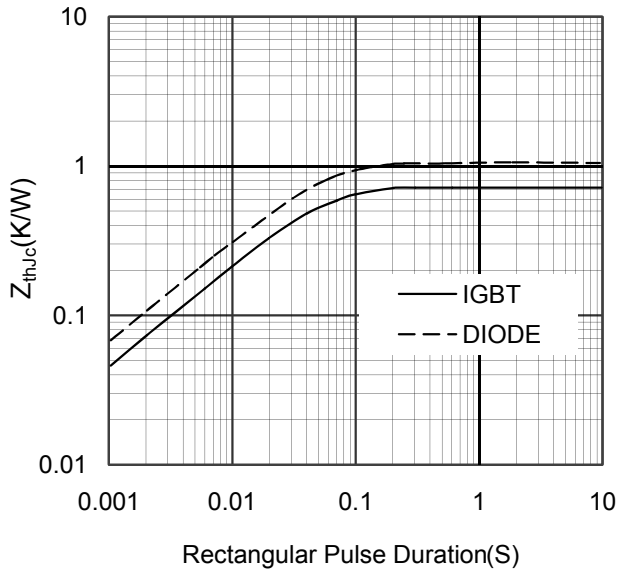

Figure 10. Transient Thermal Impedance of Diode and IGBT-inverter

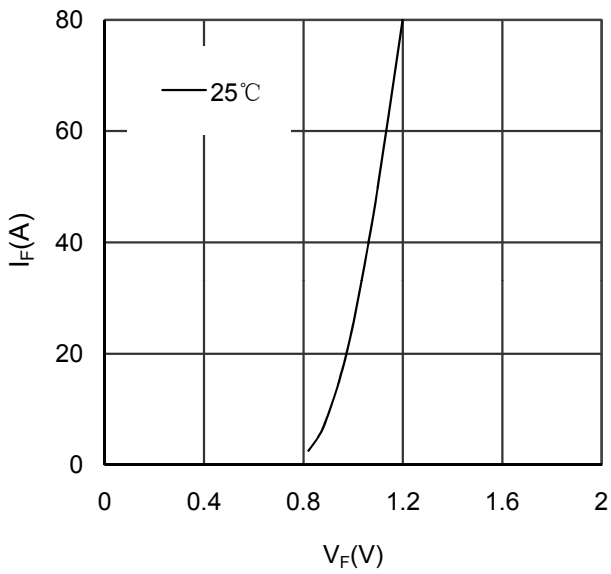

Figure 11. Diode Forward Characteristics Diode- rectifier

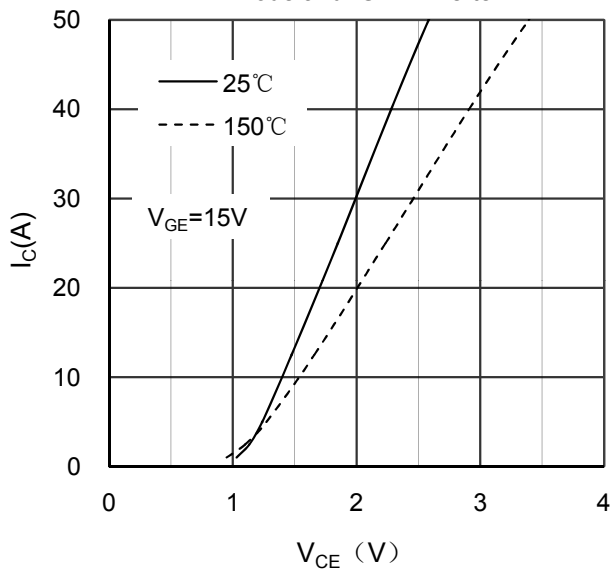

Figure 12. Typical Output Characteristics IGBT- brake chopper

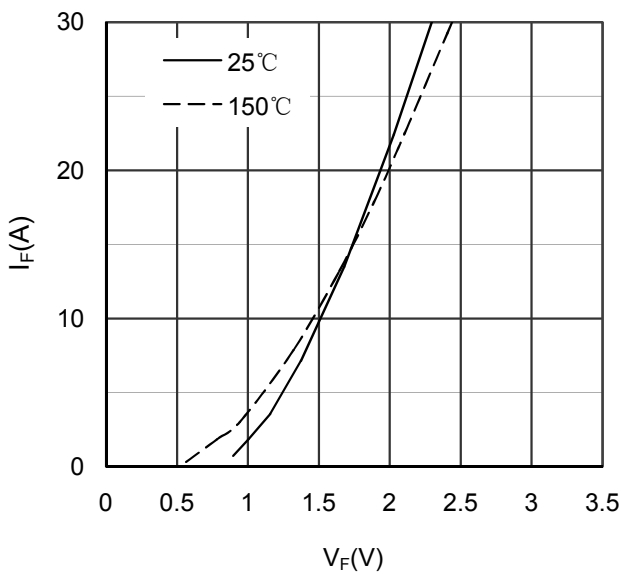

Figure 13. Diode Forward Characteristics Diode - brake chopper

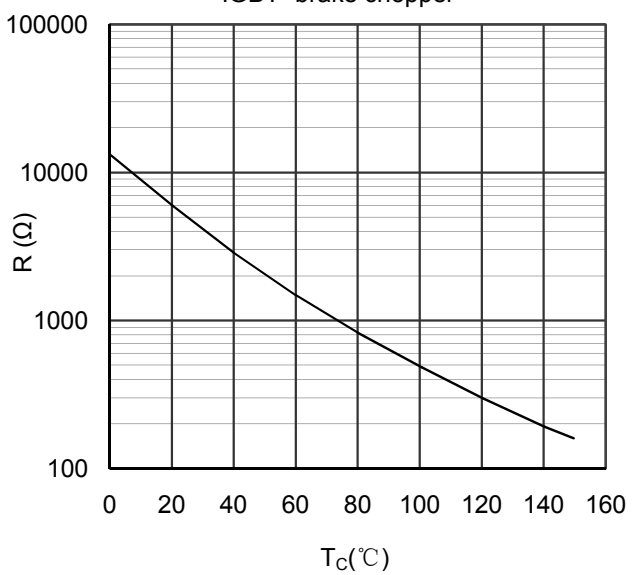

Figure 14. NTC Characteristics

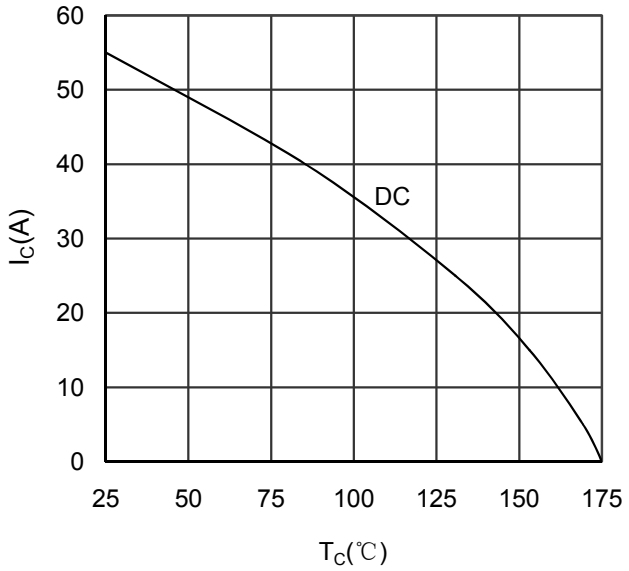

Figure 15. Collector Current vs Case temperature IGBT-inverter

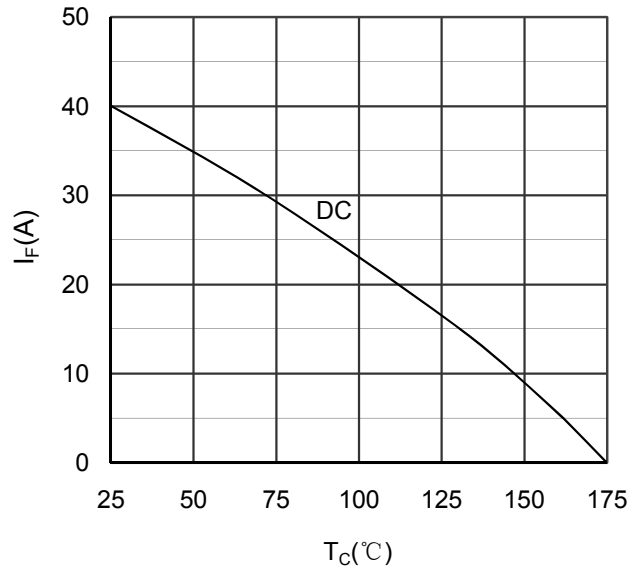

Figure 16. Forward current vs Case temperature Diode-inverter

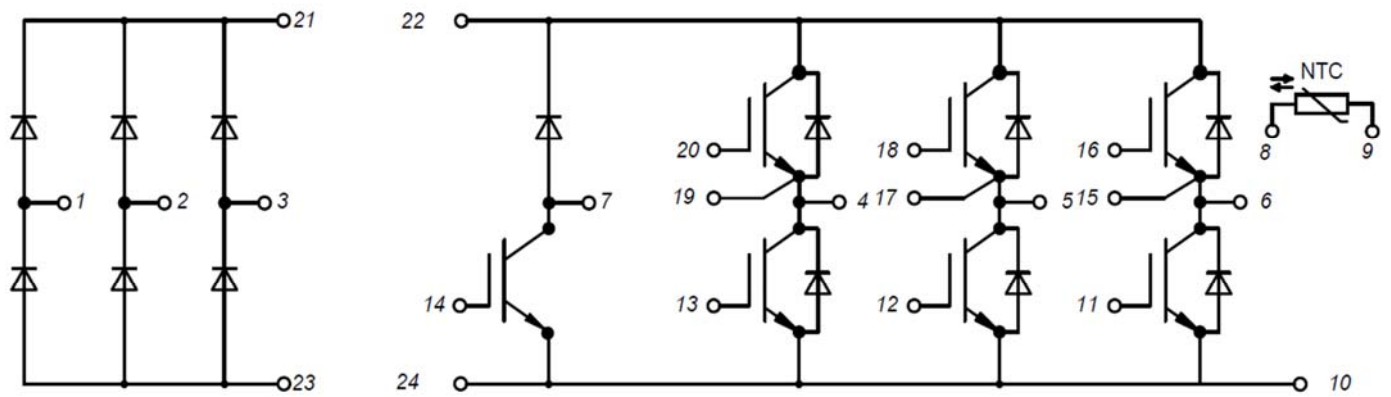
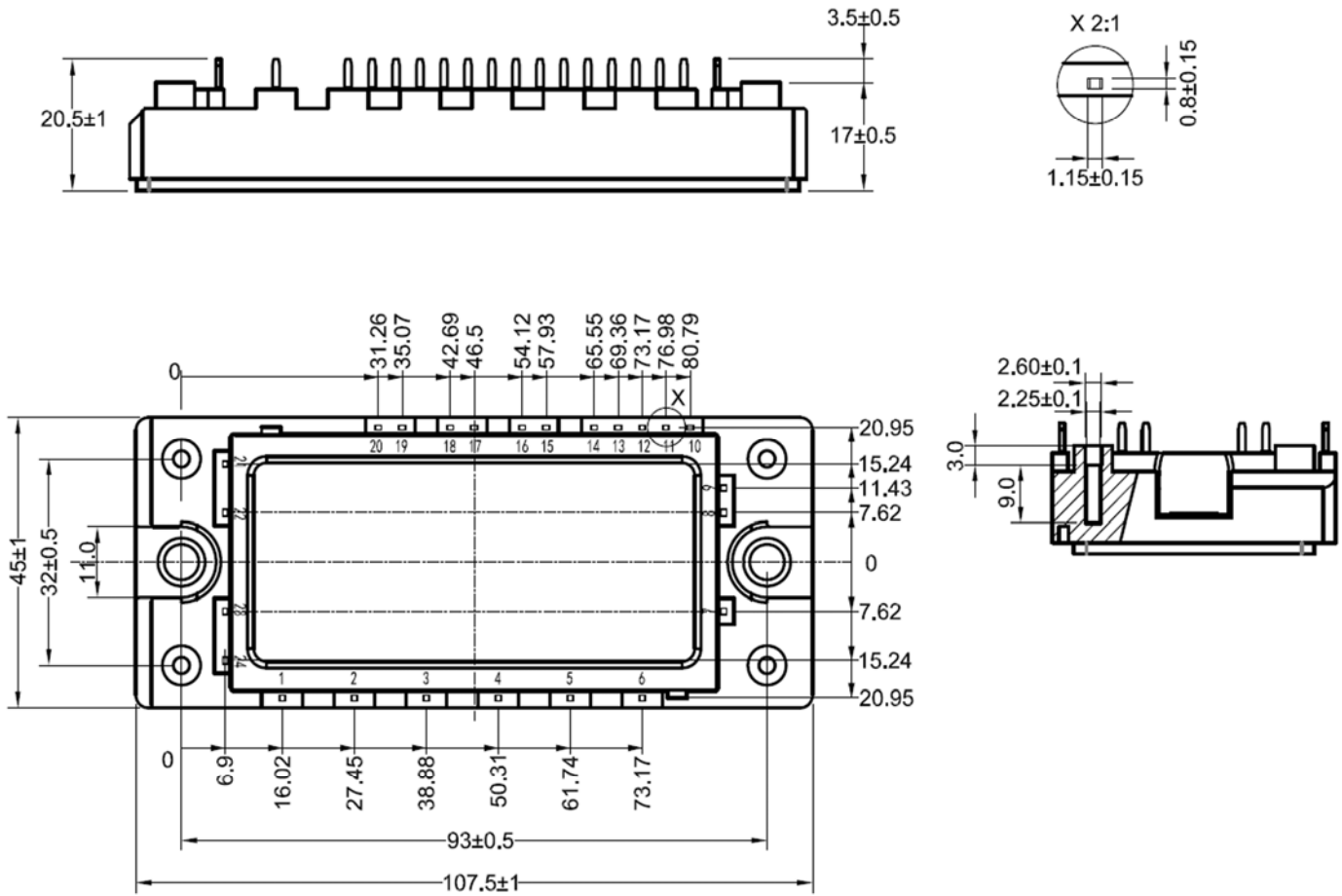

Figure 17. Circuit Diagram



Dimensions in (mm)
Figure 18. Package Outline