

PRODUCT FEATURES

- High short circuit capability, self limiting short circuit current
- IGBT CHIP(T4 Fast Trench+Field Stop technology)
- $V_{CE(sat)}$ with positive temperature coefficient
- Fast switching and short tail current
- Free wheeling diodes with fast and soft reverse recovery
- Low switching losses
- $T_{Jmax} = 175^{\circ}C$



APPLICATIONS

- High frequency switching application
- Medical applications
- Motion/servo control
- UPS systems

IGBT-inverter

ABSOLUTE MAXIMUM RATINGS ($T_C = 25^{\circ}C$ unless otherwise specified)

Symbol	Parameter/Test Conditions		Values	Unit
V_{CES}	Collector Emitter Voltage	$T_J = 25^{\circ}C$	1200	V
V_{GES}	Gate Emitter Voltage		± 20	
I_C	DC Collector Current	$T_C = 25^{\circ}C$	75	A
		$T_C = 95^{\circ}C$	50	
I_{CM}	Repetitive Peak Collector Current	$t_p = 1ms$	100	
P_{tot}	Power Dissipation Per IGBT		300	W

Diode-inverter

ABSOLUTE MAXIMUM RATINGS ($T_C = 25^{\circ}C$ unless otherwise specified)

Symbol	Parameter/Test Conditions		Values	Unit
V_{RRM}	Repetitive Reverse Voltage	$T_J = 25^{\circ}C$	1200	V
$I_{F(AV)}$	Average Forward Current	$T_C = 25^{\circ}C$	50	A
I_{FRM}	Repetitive Peak Forward Current	$t_p = 1ms$	100	
i^2t		$T_J = 125^{\circ}C, t = 10ms, V_R = 0V$	680	A^2S

MacMic Science & Technology Co., Ltd.

Add: #18, Hua Shan Zhong Lu, New District, Changzhou City, Jiangsu Province, P. R. of China
 Tel.: +86-519-85163708 Fax: +86-519-85162291 Post Code: 213022 Website: www.macmicst.com

IGBT-inverter

ELECTRICAL CHARACTERISTICS ($T_C=25^\circ\text{C}$ unless otherwise specified)

Symbol	Parameter/Test Conditions		Min.	Typ.	Max.	Unit	
$V_{GE(th)}$	Gate Emitter Threshold Voltage	$V_{CE}=V_{GE}, I_C=2\text{mA}$	5.4	6.0	6.5	V	
$V_{CE(sat)}$	Collector Emitter Saturation Voltage	$I_C=50\text{A}, V_{GE}=15\text{V}, T_J=25^\circ\text{C}$		2.1	2.5		
		$I_C=50\text{A}, V_{GE}=15\text{V}, T_J=125^\circ\text{C}$		2.5			
I_{CES}	Collector Leakage Current	$V_{CE}=1200\text{V}, V_{GE}=0\text{V}, T_J=25^\circ\text{C}$			1	mA	
		$V_{CE}=1200\text{V}, V_{GE}=0\text{V}, T_J=125^\circ\text{C}$			10	mA	
I_{GES}	Gate Leakage Current	$V_{CE}=0\text{V}, V_{GE}=\pm 15\text{V}, T_J=25^\circ\text{C}$	-400		400	nA	
R_{gint}	Integrated Gate Resistor			4		Ω	
Q_g	Gate Charge	$V_{CE}=600\text{V}, I_C=50\text{A}, V_{GE}=15\text{V}$		0.23		μC	
C_{ies}	Input Capacitance	$V_{CE}=25\text{V}, V_{GE}=0\text{V}, f=1\text{MHz}$		2.8		nF	
C_{res}	Reverse Transfer Capacitance				160		pF
$t_{d(on)}$	Turn on Delay Time	$V_{CC}=600\text{V}, I_C=50\text{A}$ $R_G=15\Omega,$ $V_{GE}=\pm 15\text{V},$ Inductive Load	$T_J=25^\circ\text{C}$	60		ns	
			$T_J=125^\circ\text{C}$	70		ns	
			$T_J=150^\circ\text{C}$	80		ns	
t_r	Rise Time		$T_J=25^\circ\text{C}$	40		ns	
			$T_J=125^\circ\text{C}$	50		ns	
			$T_J=150^\circ\text{C}$	55		ns	
$t_{d(off)}$	Turn off Delay Time	$T_J=25^\circ\text{C}$	280		ns		
		$T_J=125^\circ\text{C}$	320		ns		
		$T_J=150^\circ\text{C}$	360		ns		
t_f	Fall Time	$T_J=25^\circ\text{C}$	40		ns		
		$T_J=125^\circ\text{C}$	60		ns		
		$T_J=150^\circ\text{C}$	70		ns		
E_{on}	Turn on Energy	$V_{CC}=600\text{V}, I_C=50\text{A}$ $R_G=15\Omega,$ $V_{GE}=\pm 15\text{V},$ Inductive Load	$T_J=125^\circ\text{C}$	5		mJ	
			$T_J=150^\circ\text{C}$	5.5		mJ	
E_{off}	Turn off Energy		$T_J=125^\circ\text{C}$	3		mJ	
			$T_J=150^\circ\text{C}$	3.3		mJ	
I_{sc}	Short Circuit Current		$t_{psc}\leq 10\mu\text{s}, V_{GE}=15\text{V}$ $T_J=125^\circ\text{C}, V_{CC}=600\text{V}$		200		A
R_{thJC}	Junction to Case Thermal Resistance (Per IGBT)				0.5	K /W	

Diode-inverter

ELECTRICAL CHARACTERISTICS ($T_C=25^\circ\text{C}$ unless otherwise specified)

Symbol	Parameter/Test Conditions		Min.	Typ.	Max.	Unit
V_F	Forward Voltage	$I_F=50\text{A}, V_{GE}=0\text{V}, T_J=25^\circ\text{C}$		1.65	2.15	V
		$I_F=50\text{A}, V_{GE}=0\text{V}, T_J=125^\circ\text{C}$		1.65		
t_{rr}	Reverse Recovery Time	$I_F=50\text{A}, V_R=600\text{V}$		330		ns
I_{RRM}	Max. Reverse Recovery Current	$di_F/dt=-1300\text{A}/\mu\text{s}$		55		A
Q_{RR}	Reverse Recovery Charge	$T_J=125^\circ\text{C}$		8.5		μC
E_{rec}	Reverse Recovery Energy			3.2		mJ
R_{thJCD}	Junction to Case Thermal Resistance (Per Diode)				0.78	K /W

NTC CHARACTERISTICS ($T_C=25^\circ\text{C}$ unless otherwise specified)

Symbol	Parameter/Test Conditions		Min.	Typ.	Max.	Unit
R_{25}	Resistance	$T_C = 25^\circ\text{C}$		5		K Ω
$B_{25/50}$	$R_2 = R_{25} \exp [B_{25/50}(1/T_2 - 1/(298.15 \text{ K}))]$			3375		K

MODULE CHARACTERISTICS ($T_C=25^\circ\text{C}$ unless otherwise specified)

Symbol	Parameter/Test Conditions		Values	Unit
T_{Jmax}	Max. Junction Temperature		175	$^\circ\text{C}$
T_{Jop}	Operating Temperature		-40~150	
T_{stg}	Storage Temperature		-40~125	
V_{isol}	Isolation Breakdown Voltage	AC, 50Hz(R.M.S), t=1minute	3000	V
CTI	Comparative Tracking Index		>225	
Md	Mounting Torque	Recommended (M5)	2.5~5	Nm
Weight			200	g

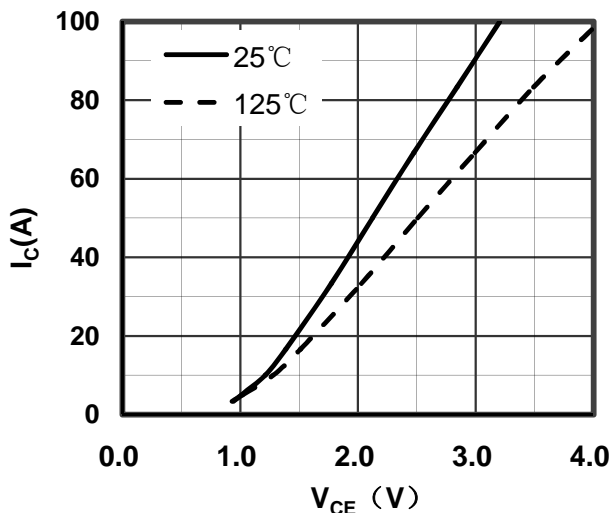

Figure 1. Typical Output Characteristics IGBT-inverter

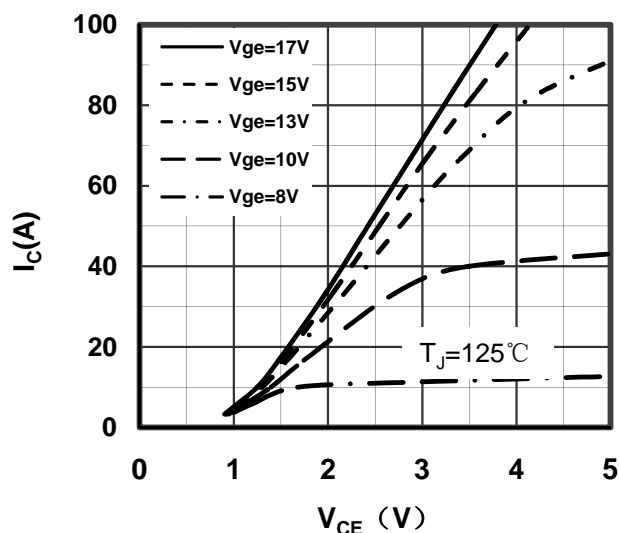

Figure 2. Typical Output Characteristics IGBT-inverter

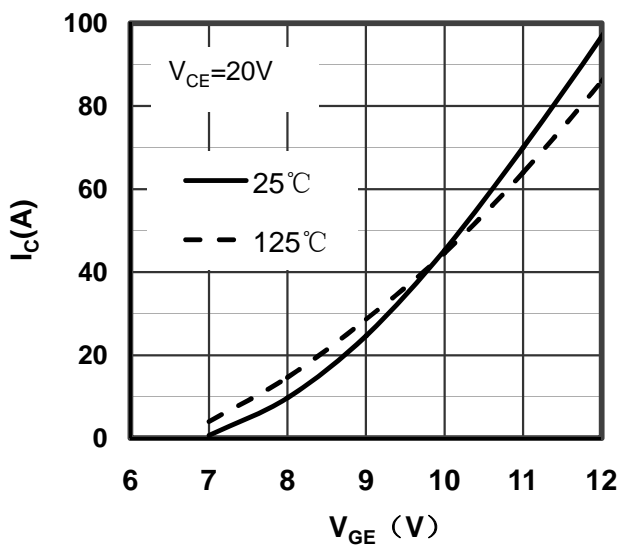

Figure 3. Typical Transfer Characteristics IGBT-inverter

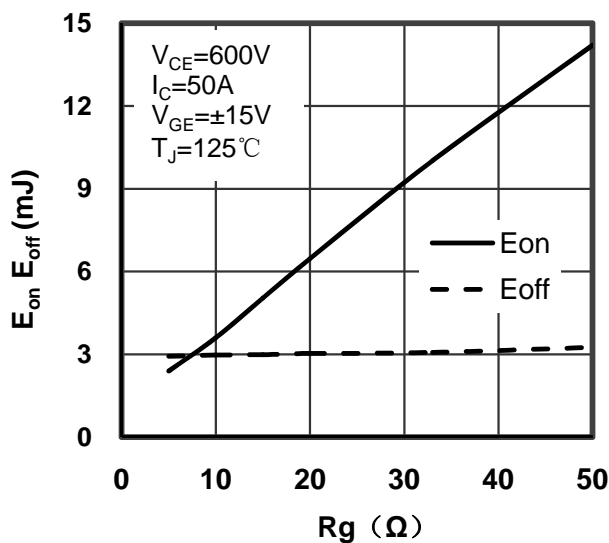

Figure 4. Switching Energy vs Gate Resistor IGBT-inverter

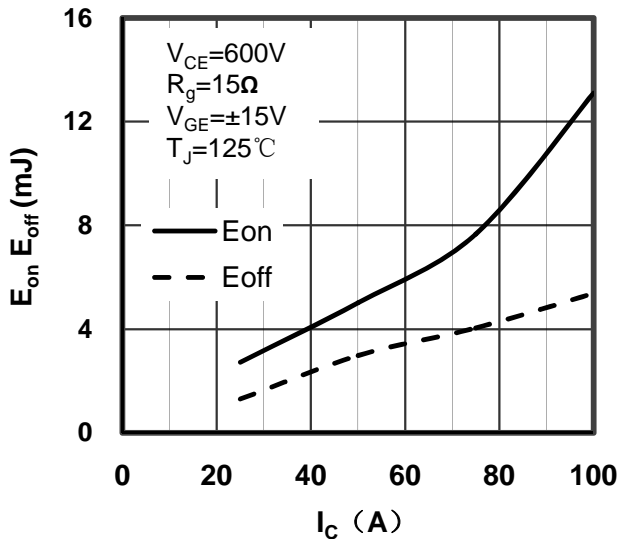

Figure 5. Switching Energy vs Collector Current IGBT-inverter

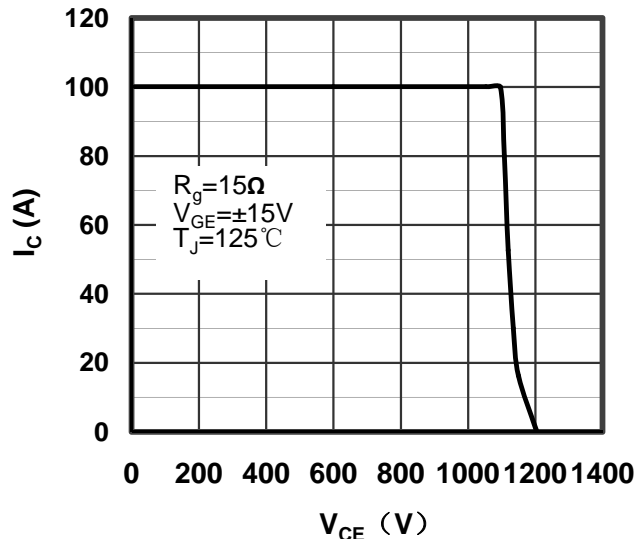

Figure 6. Reverse Biased Safe Operating Area IGBT-inverter

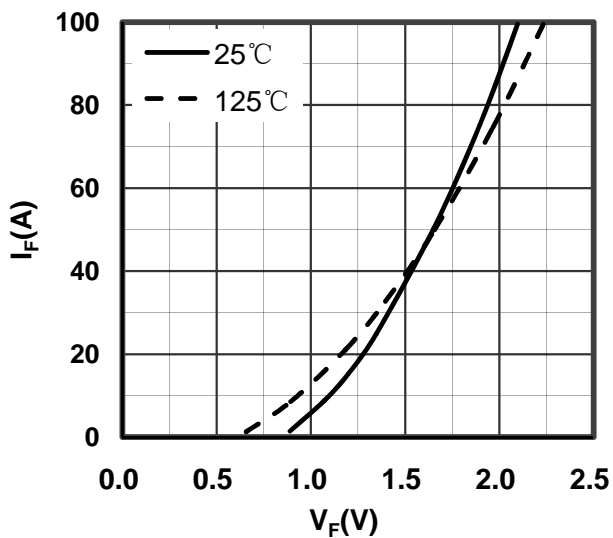

Figure 7. Diode Forward Characteristics Diode-inverter

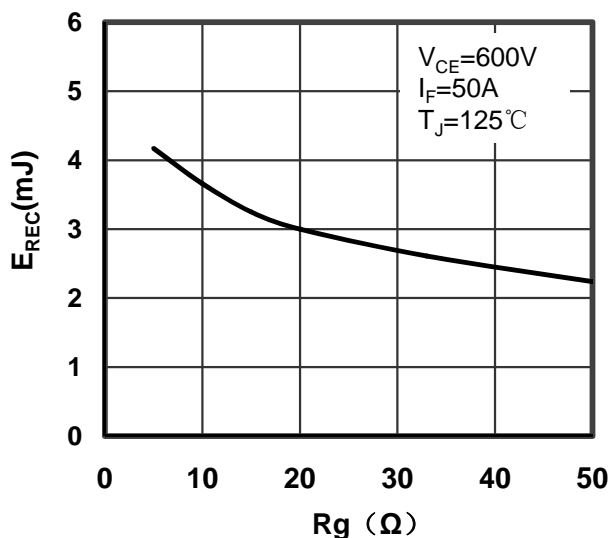

Figure 8. Switching Energy vs Gate Resistor Diode-inverter

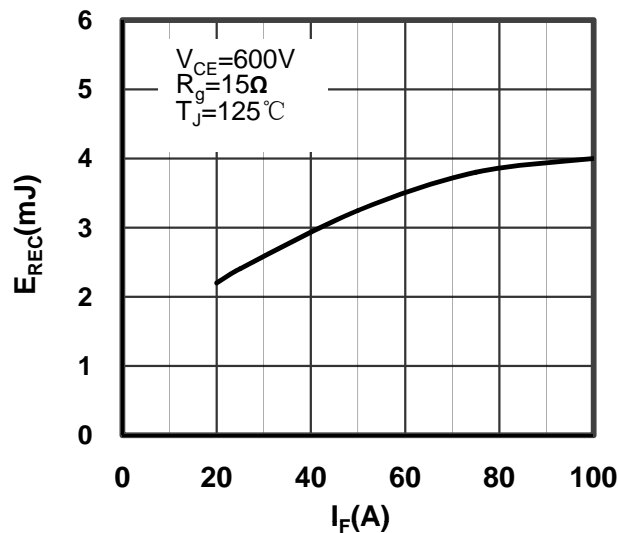

Figure 9. Switching Energy vs Forward Current Diode-inverter

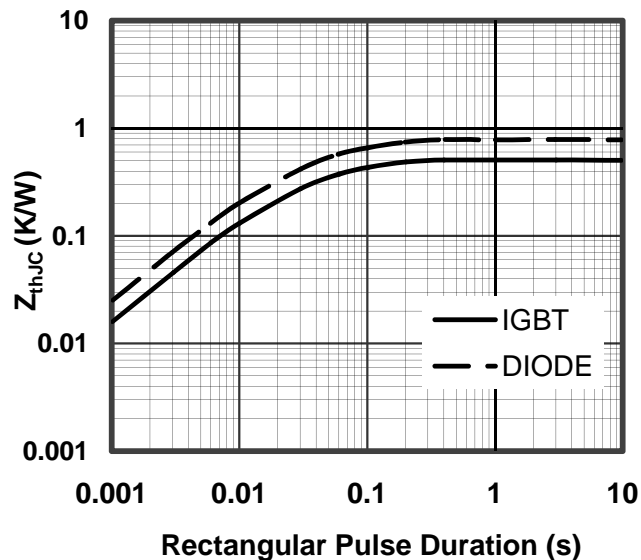

Figure 10. Transient Thermal Impedance of Diode and IGBT-inverter

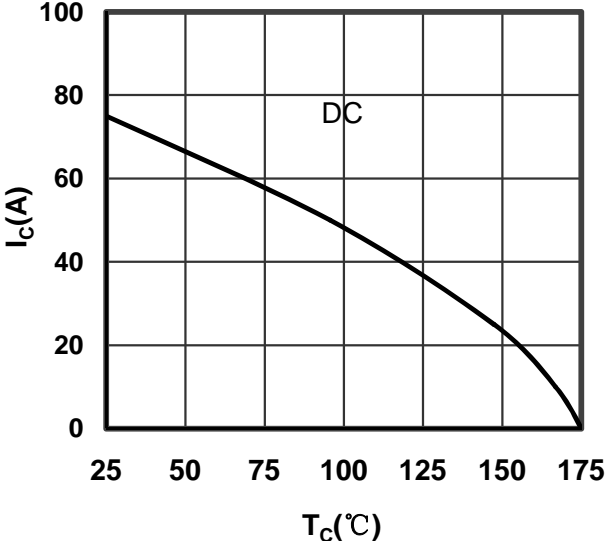

Figure 11. Collector Current vs Case temperature IGBT -inverter

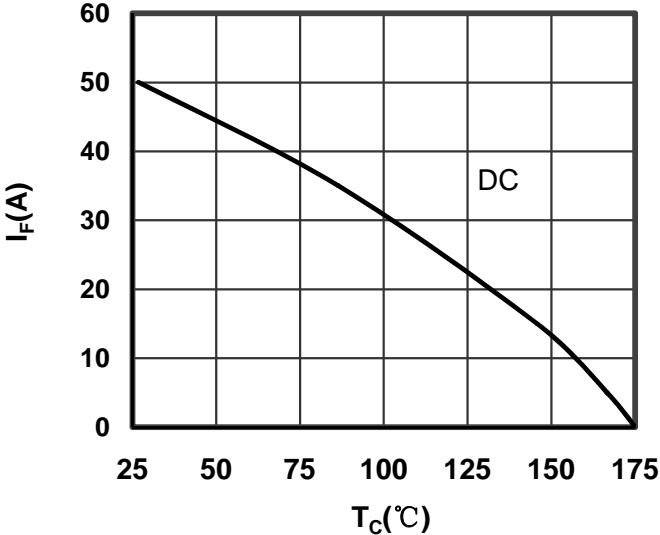

Figure 12. Forward current vs Case temperature Diode -inverter

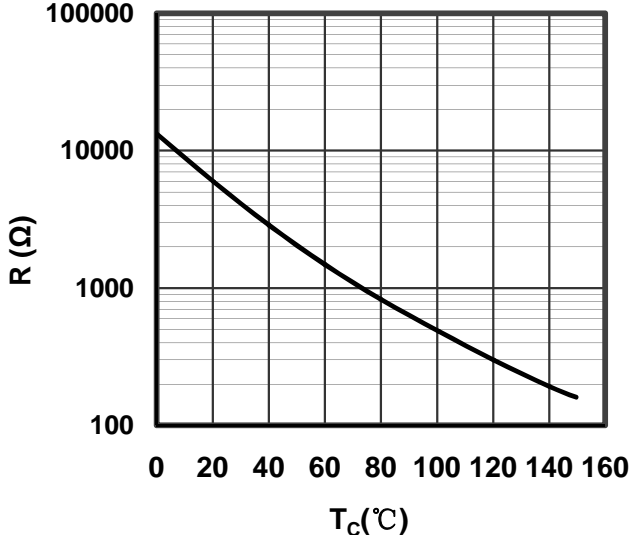

Figure 13. NTC Characteristics

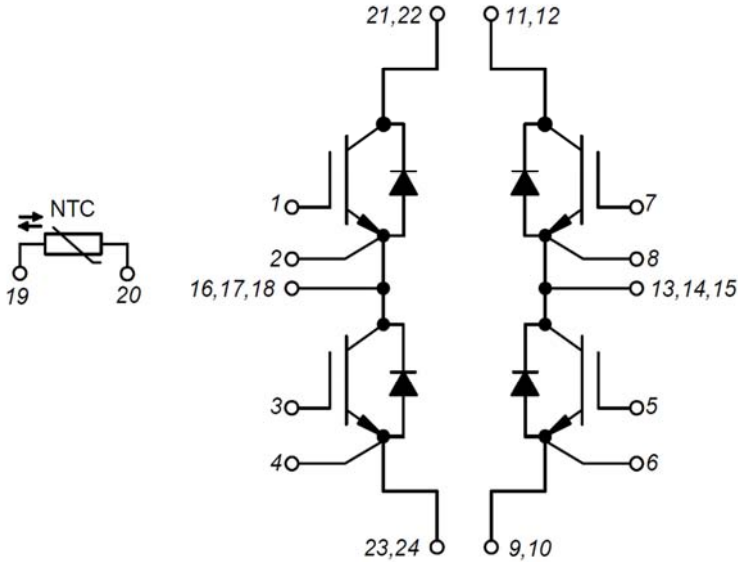
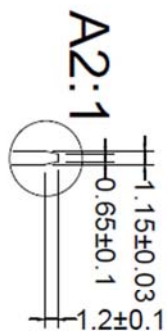
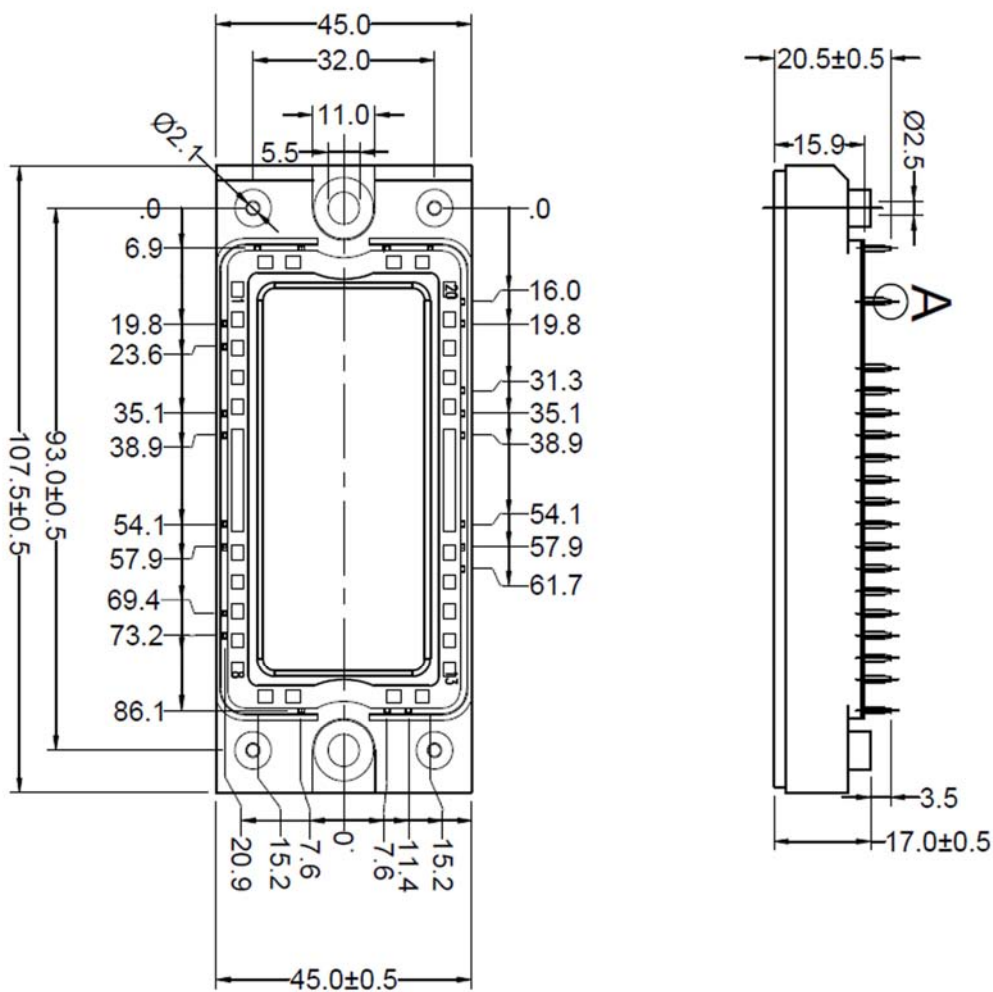

Figure 14. Circuit Diagram



Dimensions in (mm)
Figure 15. Package Outline